

NOKIA

Nokia C1 2nd Edition

User Guide

Table of Contents

1	About this user guide	5
2	Get started	6
	Keep your phone up to date	6
	Keys and parts	6
	Insert the SIM and memory cards	7
	Charge your phone	8
	Switch on and set up your phone	9
	Dual SIM settings	9
	Lock or unlock your phone	10
	Use the touch screen	10
3	Basics	14
	Personalize your phone	14
	Notifications	14
	Control volume	15
	Automatic text correction	16
	Battery life	16
	Accessibility	17
	FM Radio	17
4	Connect with your friends and family	19
	Calls	19
	Contacts	19
	Send messages	20
	Mail	20
5	Camera	21
	Camera basics	21
	Videos	21
	Your photos and videos	21

6 Internet and connections	23
Activate Wi-Fi	23
Browse the web	23
Bluetooth®	24
VPN	25
7 Organize your day	26
Date and time	26
Alarm clock	26
Calendar	27
8 Maps	28
Find places and get directions	28
9 Apps, updates, and backups	29
Get apps from Google Play	29
Free up space on your phone	29
Update your phone software	30
Back up your data	30
Restore original settings and remove private content from your phone	30
10 Protect your phone	31
Protect your phone with a screen lock	31
Protect your phone with your face	31
Change your SIM PIN code	32
Access codes	32
11 Product and safety information	34
For your safety	34
Network services and costs	37
Emergency calls	37
Take care of your device	37

Recycle	38
Crossed-out wheelee bin symbol	39
Battery and charger information	39
Small children	40
Medical devices	40
Implanted medical devices	41
Hearing	41
Protect your device from harmful content	41
Vehicles	42
Potentially explosive environments	42
Certification information	42
About Digital Rights Management	43
Copyrights and other notices	43

1 About this user guide



Important: For important information on the safe use of your device and battery, read “Product and safety information” before you take the device into use. To find out how to get started with your new device, read the user guide.

2 Get started

KEEP YOUR PHONE UP TO DATE

Your phone software

Keep your phone up to date and accept available software updates to get new and enhanced features for your phone. Updating the software may also improve your phone's performance.

KEYS AND PARTS

Your phone

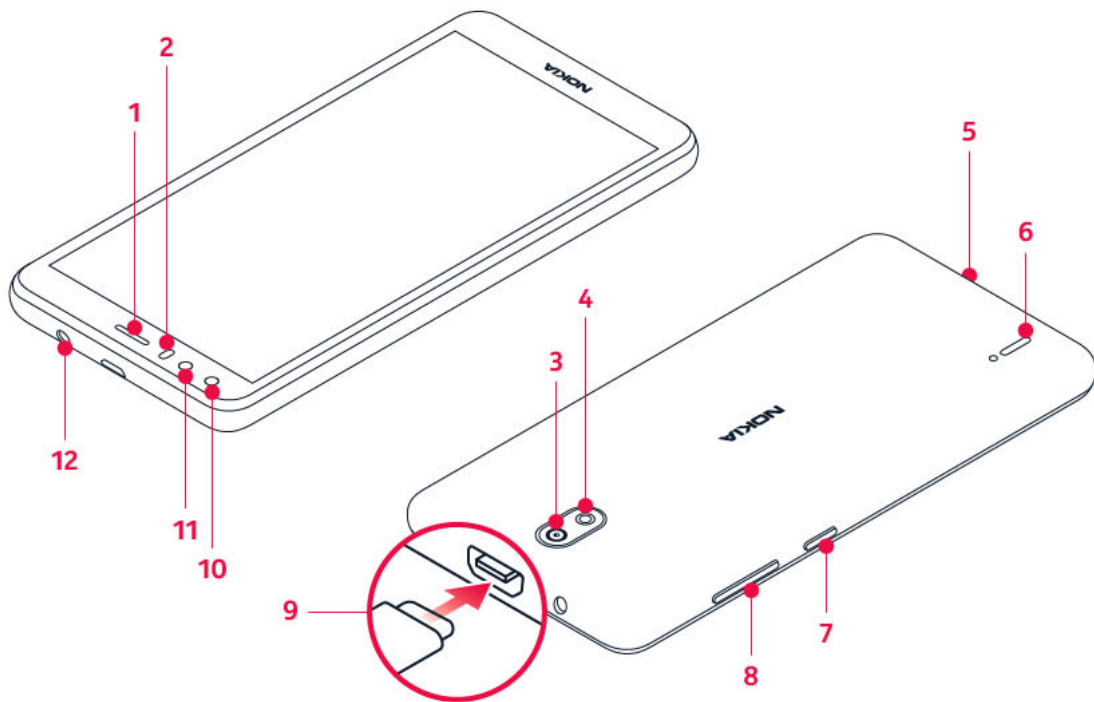

This user guide applies to the following model: TA-1380.

- | | |
|---------------------|-----------------------|
| 1. Earpiece | 7. Power/Lock key |
| 2. Proximity sensor | 8. Volume keys |
| 3. Camera | 9. USB connector |
| 4. Flash | 10. Flash |
| 5. Microphone | 11. Front camera |
| 6. Loudspeaker | 12. Headset connector |

Some of the accessories mentioned in this user guide, such as charger, headset, or data cable, may be sold separately.

Parts and connectors, magnetism

Do not connect to products that create an output signal, as this may damage the device. Do not connect any voltage source to the audio connector. If you connect an external device or headset, other than those approved for use with this device, to the audio connector, pay special attention to volume levels.

Parts of the device are magnetic. Metallic materials may be attracted to the device. Do not place credit cards or other magnetic stripe cards near the device for extended periods of time, since the cards may be damaged.

INSERT THE SIM AND MEMORY CARDS

Insert the cards

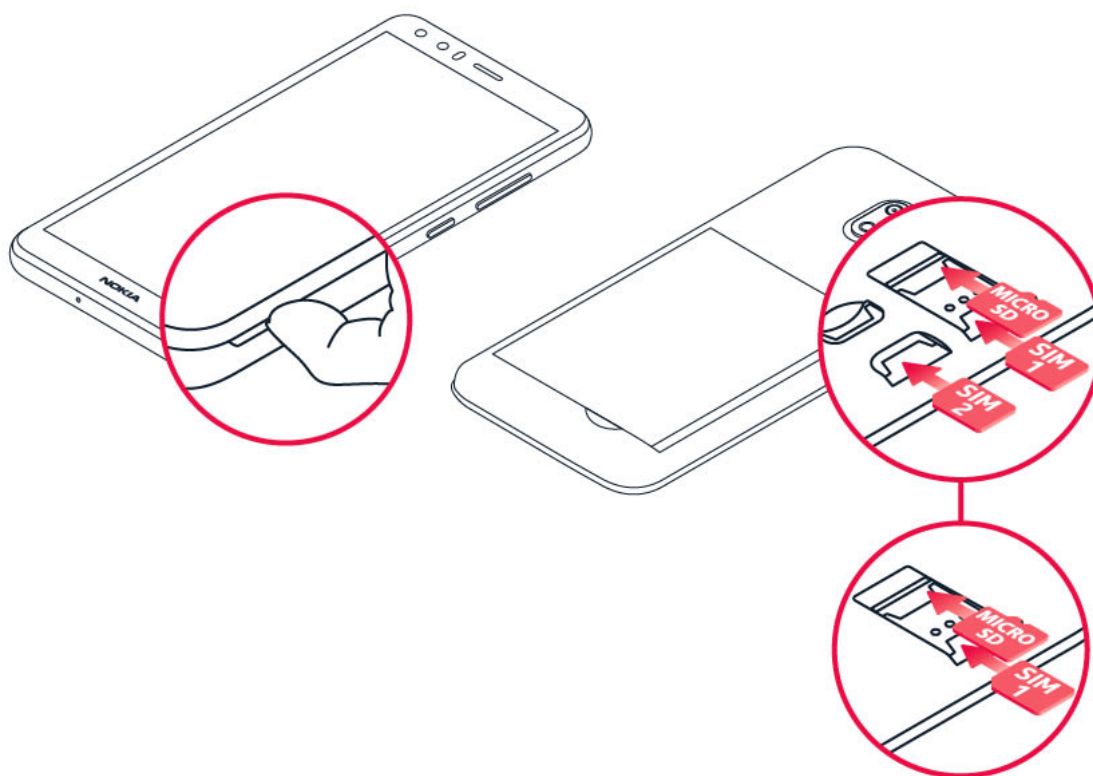

1. Put your fingernail in the back cover opening slot, bend the back cover open, and remove it.
2. Slide the nano-SIM in slot 1 with the contact area face down.
3. If you have a second SIM card, slide it in the SIM2 slot.
4. If you have a memory card, slide it in the memory card slot.
5. Put back the back cover.

Use only original nano-SIM cards. Use of incompatible SIM cards may damage the card or the device, and may corrupt data stored on the card.

Use only compatible memory cards approved for use with this device. Incompatible cards may damage the card and the device and corrupt data stored on the card.



Note: Switch the device off and disconnect the charger and any other device before removing any covers. Avoid touching electronic components while changing any covers. Always store and use the device with any covers attached.



Important: Do not remove the memory card when an app is using it. Doing so may damage the memory card and the device and corrupt data stored on the card.



Tip: Use a fast, up to 128 GB microSD memory card from a well-known manufacturer.

CHARGE YOUR PHONE

Charge the battery



1. Plug a compatible charger into a wall outlet.
2. Connect the cable to your phone.

Your phone supports the USB micro-B cable. You can also charge your phone from a computer with a USB cable, but it may take a longer time.

If the battery is completely discharged, it may take several minutes before the charging indicator is displayed.

SWITCH ON AND SET UP YOUR PHONE

When you switch your phone on for the first time, your phone guides you to set up your network connections and phone settings.

Switch on your phone

1. To switch on your phone, press and hold the power key until the phone vibrates.
2. When the phone is switched on, choose your language and region.
3. Follow the instructions shown on your phone.

Transfer data from your previous phone

You can transfer data from an old phone to your new phone using your Google account.

To back up data on your old phone to your Google account, refer to your old phone's user guide.

1. Tap **Settings** > **Accounts** > **Add account** > **Google**.
2. Select which data you want to restore on your new phone. The sync starts automatically once your phone is connected to the internet.

Restore app settings from your previous Android™ phone

If your previous phone was an Android, and back up to Google account is enabled on it, you can restore your app settings and Wi-Fi passwords.

1. Tap **Settings** > **System** > **Backup**.
2. Switch **Backup to Google Drive** to **On**.

DUAL SIM SETTINGS

If you have a dual-SIM phone, you can have 2 SIMs in your phone, for example, one for your work and one for your personal use.

Choose which SIM to use

When, for example, making a call, you can choose which SIM to use by tapping the corresponding SIM 1 or SIM 2 button after you dial the number.

Your phone shows the network status for both SIMs separately. Both SIM cards are available at the same time when the device is not being used, but while one SIM card is active, when, for example, making a call, the other may be unavailable.

Manage your SIMs

Don't want work to interfere with your free time? Or do you have a cheaper data connection on one SIM? You can decide which SIM you want to use.

Tap **Settings** > **Network & internet** > **Mobile network**, and tap the SIM card.

Rename a SIM card

1. Tap  next to the SIM you want to rename.
2. Type in the name.
3. Select a color for the SIM card, if you want.
4. Tap **SAVE**.

LOCK OR UNLOCK YOUR PHONE

Lock your phone

If you want to avoid accidentally making a call when your phone is in your pocket or bag, you can lock your keys and screen.

To lock your keys and screen, press the power key.

Unlock the keys and screen

Press the power key, and swipe up across the screen. If asked, provide additional credentials.

USE THE TOUCH SCREEN

Important: Avoid scratching the touch screen. Never use an actual pen, pencil, or other sharp object on the touch screen.

Tap and hold to drag an item



Place your finger on the item for a couple of seconds, and slide your finger across the screen.

Swipe



Place your finger on the screen, and slide your finger in the direction you want.

Scroll through a long list or menu



Slide your finger quickly in a flicking motion up or down the screen, and lift your finger. To stop the scrolling, tap the screen.

Zoom in or out



Place 2 fingers on an item, such as a map, photo, or web page, and slide your fingers apart or together.

Navigate with keys

- To see all your apps, swipe up the home key ●.
- To go to the home screen, tap the home key. The app you were in stays open in the background.
- To see which apps you have open, tap ■.
- To switch to another open app, swipe right and tap the app.
- To close all the open apps, tap **CLEAR ALL**.
- To go back to the previous screen you were in, tap ◀. Your phone remembers all the apps and websites you've visited since the last time your screen was locked.

3 Basics

PERSONALIZE YOUR PHONE

Change your wallpaper

Tap **Settings** > **Display** > **Advanced** > **Wallpaper**.

Change your phone ringtone

Tap **Settings** > **Sound** > **Phone ringtone SIM1** or **Phone ringtone SIM2**, and select the tone.

Change your message notification sound

Tap **Settings** > **Sound** > **Advanced** > **Default notification sound**.

NOTIFICATIONS

Use the notification panel

When you receive new notifications, such as messages or missed calls, icons appear at the top of the screen.

To see more information about the notifications, swipe down from the top of the screen. To close the view, swipe up on the screen.

To change the notification settings of an app, tap **Settings** > **Apps & notifications**, tap the app name and **Notifications**.

Use the quick setting icons



To activate features, tap the quick settings icons on the notification panel. To see more icons, drag the menu down.

To rearrange the icons, tap , tap and hold an icon, and then drag it to another location.

CONTROL VOLUME

Change the volume



If you have trouble hearing your phone ringing in noisy environments, or calls are too loud, you can change the volume to your liking by using the volume keys on the side of your phone.

Do not connect to products that create an output signal, as this may damage the device. Do not connect any voltage source to the audio connector. If you connect an external device or headset, other than those approved for use with this device, to the audio connector, pay special attention to volume levels.

Change the volume for media and apps

Press a volume key on the side of your phone to see the volume status bar, tap , and drag the slider on the volume bar for media and apps left or right.

Set the phone to silent

To set the phone to silent, press the volume down key, tap  to set your phone to vibrate only and tap  to set it to silent.

AUTOMATIC TEXT CORRECTION

Use keyboard word suggestions

Your phone suggests words as you write, to help you write quickly and more accurately. Word suggestions may not be available in all languages.

When you start writing a word, your phone suggests possible words. When the word you want is shown in the suggestion bar, select the word. To see more suggestions, tap and hold the suggestion.



Tip: If the suggested word is marked in bold, your phone automatically uses it to replace the word you wrote. If the word is wrong, tap and hold it to see a few other suggestions.

If you do not want the keyboard to suggest words while typing, turn off the text corrections. Tap **Settings** > **System** > **Languages & input** > **On-screen keyboard**. Select the keyboard you normally use. Tap **Text correction** and switch off the text correction methods you do not want to use.

Correct a word

If you notice that you have misspelled a word, tap it to see suggestions for correcting the word.

BATTERY LIFE

There are steps you can take to save power on your phone.

Extend battery life

To save power:

1. Always charge the battery fully.
2. Mute unnecessary sounds, such as touch sounds. Tap **Settings** > **Sound** > **Advanced**, and under **Other sounds and vibrations**, select which sounds to keep.
3. Use wired headphones, rather than the loudspeaker.
4. Set the phone screen to switch off after a short time. Tap **Settings** > **Display** > **Advanced** > **Screen timeout** and select the time.
5. Tap **Settings** > **Display** > **Brightness level**. To adjust the brightness, drag the brightness level slider. Make sure that **Adaptive brightness** is disabled.
6. Stop apps from running in the background: tap **■** > **CLEAR ALL**.
7. Use location services selectively: switch location services off when you don't need them. Tap **Settings** > **Location**, and disable **Use location**.
8. Use network connections selectively: switch Bluetooth on only when needed.

Use a Wi-Fi connection to connect to the internet, rather than a mobile data connection. Stop your phone scanning for available wireless networks. Tap **Settings** > **Network & Internet** > **Wi-Fi**, and disable **Use Wi-Fi**. If you're listening to music or otherwise using your phone, but don't

want to make or receive calls, switch the airplane mode on. Tap **Settings** > **Network & Internet** > **Airplane mode**. Airplane mode closes connections to the mobile network and switches your device's wireless features off.

ACCESSIBILITY

You can change various settings to make using your phone easier.

Increase or decrease the font size

Do you want to have larger fonts on your phone?

1. Tap **Settings** > **Accessibility**.
2. Tap **Font size**. To increase or decrease the font size, drag the font size level slider.

Increase or decrease the display size

Do you want to make the items on your screen smaller or larger?

1. Tap **Settings** > **Accessibility**.
2. Tap **Display size** and to adjust the display size, drag the display size level slider.

FM RADIO

To listen to the radio, you need to connect a compatible headset to the phone. The headset acts as an antenna. The headset may be sold separately.

Listen to FM radio

After you have connected the headset, tap **FM Radio**.

- To switch the radio on, tap **▶**. channel frequency row left or right.
- To find radio stations, tap **⋮** > **Scan**. • To save a station, tap **⋮**.
- To switch to another station, slide the **▶**. • To listen to a radio station using the

phone's speakers, tap . Keep the headset connected.

- To switch the radio off, tap .



Troubleshooting tip: If the radio doesn't work, make sure the headset is connected properly.

4 Connect with your friends and family

CALLS

Make a call

1. Tap .
2. Tap  and type in a number, or tap  and select a contact you want to call.
3. Tap . If you have a second SIM card inserted, tap the corresponding icon to make a call from that SIM.

Answer a call

If your phone rings when the screen is unlocked, tap **ANSWER**. If your phone rings when the screen is locked, swipe up to answer.

Reject a call

If your phone rings when the screen is unlocked, tap **DECLINE**. If your phone rings when the screen is locked, swipe down to reject the call.

CONTACTS

Save a contact from call history





1. Tap  >  to see your call history.
2. Tap the number you want to save.
3. Tap **Add contact**. If this is a new contact, type in the contact information, and tap **Save**. If this contact is already in your contacts list, tap **Add to existing**, select the contact, and tap **Save**.

Add a contact

1. Tap **Contacts** > .
2. Fill out the information.
3. Tap **Save**.

SEND MESSAGES

Send a message

1. Tap **Messages**.
2. Tap **Start chat**.
3. To add a recipient, tap , type in their number, and tap . To add a recipient from your contacts list, start typing their name and tap the contact.
4. To add more recipients, tap . After choosing all the recipients, tap **Next**.
5. Write your message in the text box.
6. Tap .

MAIL



You can send mail with your phone when you're on the go.

Add a mail account

When you use the Gmail app for the first time, you are asked to set up your email account.

1. Tap **Gmail**.
2. You can select the address connected with your Google account or tap **Add an email address**.
3. After adding all the accounts, tap **TAKE ME TO GMAIL**.

Send mail

1. Tap **Gmail**.
2. Tap .
3. In the **To** box, type in an address, or tap  > **Add from Contacts**.
4. Type in the message subject and the mail.
5. Tap .

5 Camera



CAMERA BASICS

Take a photo



Shoot sharp and vibrant photos – capture the best moments in your photo album.

1. Tap **Camera**.
2. Take aim and focus.
3. Tap .

Take a selfie



1. Tap **Camera** >  to switch to the front camera.
2. Tap .

Take photos with a timer

1. Tap **Camera**.
2. Tap  and select the time.
3. Tap .

VIDEOS

Record a video

1. Tap **Camera**.
2. To switch to the video recording mode, tap **Video**.
3. Tap  to start recording.
4. To stop recording, tap .
5. To go back to camera mode, tap **Photo**.

YOUR PHOTOS AND VIDEOS

View photos and videos on your phone

Tap **Gallery**.

Share your photos and videos

1. Tap **Gallery**, tap the photo you want to share and tap .
2. Select how you want to share the photo or video.

Copy your photos and videos to your computer

Do you want to view your photos or videos on a larger screen? Move them to your computer.

You can use your computer's file manager to copy or move your photos and videos to the computer.

Connect your phone to the computer with a compatible USB cable. To set the USB connection type, open the notification panel, and tap the USB notification.

6 Internet and connections

ACTIVATE WI-FI

Using a Wi-Fi connection is generally faster and less expensive than using a mobile data connection. If both Wi-Fi and mobile data connections are available, your phone uses the Wi-Fi connection.

Turn on Wi-Fi

1. Tap **Settings** > **Network & internet** > **Wi-Fi**.
2. Switch **Use Wi-Fi** on.
3. Select the connection you want to use.

Your Wi-Fi connection is active when  is shown on the status bar at the top of the screen.

Important: Use encryption to increase the security of your Wi-Fi connection. Using encryption reduces the risk of others accessing your data.



Tip: If you want to track locations when satellite signals are not available, for example when you're indoors or between tall buildings, switch Wi-Fi on to improve positioning accuracy.

BROWSE THE WEB

Search the web

1. Tap **Chrome**.
2. Write a search word or a web address to the search field.
3. Tap , or select from the proposed matches.



Tip: If your network service provider doesn't charge you a fixed fee for data transfer, to save on data costs, use a Wi-Fi network to connect to the internet.

Use your phone to connect your computer to the web

Use your mobile data connection to access the internet with your laptop or other device.

1. Tap **Settings** > **Network & internet** > **Hotspot & tethering**.

2. Switch on **Wi-Fi hotspot** to share your mobile data connection over Wi-Fi, **USB tethering** to use a USB connection, **Bluetooth tethering** to use Bluetooth, or **Ethernet tethering** to use a USB Ethernet cable connection.

The other device uses data from your data plan, which may result in data traffic costs. For info on availability and costs, contact your network service provider.

BLUETOOTH®

You can connect wirelessly to other compatible devices, such as phones, computers, headsets, and car kits. You can also send your photos to compatible phones or to your computer.

Connect to a Bluetooth device

You can connect your phone with many useful Bluetooth devices. For example, with a wireless headset (sold separately), you can speak on the phone hands-free – you can continue what you're doing, such as working at your computer, during a call. Connecting a phone to a Bluetooth device is called pairing.

1. Tap **Settings** > **Connected devices** > **Connection preferences** > **Bluetooth**.
2. Switch **Bluetooth** to **On**.
3. Make sure the other device is switched on. You may need to start the pairing process from the other device. For details, see the user guide for the other device.
4. Tap **Pair new device** and tap the device you want to pair with from the list of discovered Bluetooth devices.
5. You may need to type in a passcode. For details, see the user guide for the other device.

Since devices with Bluetooth wireless technology communicate using radio waves, they do not need to be in direct line-of-sight. Bluetooth devices must, however, be within 10 meters (33 feet) of each other, although the connection may be subject to interference from obstructions such as walls or from other electronic devices.

Paired devices can connect to your phone when Bluetooth is switched on. Other devices can detect your phone only if the Bluetooth settings view is open.

Do not pair with or accept connection requests from an unknown device. This helps to protect your phone from harmful content.

Share your content using Bluetooth

If you want to share your photos or other content with a friend, send them to your friend's phone using Bluetooth.

You can use more than one Bluetooth connection at a time. For example, while using a Bluetooth headset, you can still send things to another phone.

1. Tap **Settings** > **Connected devices** > **Connection preferences** > **Bluetooth**.
tap  > **Bluetooth**.
2. Make sure Bluetooth is switched on in both phones and the phones are visible to each other.
3. Go to the content you want to send, and
4. On the list of found Bluetooth devices, tap your friend's phone.
5. If the other phone needs a passcode, type in or accept the passcode, and tap **PAIR**.

The passcode is only used when you connect to something for the first time.

Remove a pairing

If you no longer have the device with which you paired your phone, you can remove the pairing.

1. Tap **Settings** > **Connected devices** > **PREVIOUSLY CONNECTED DEVICES**.
2. Tap  next to a device name.
3. Tap **FORGET**.

VPN

You may need a virtual private network (VPN) connection to access your company resources, such as intranet or corporate mail, or you may use a VPN service for personal purposes.

Contact your company IT administrator for details of your VPN configuration, or check your VPN service's website for additional info.

Use a secure VPN connection

1. Tap **Settings** > **Network & Internet** > **Advanced** > **VPN**.
2. To add a VPN profile, tap **+**.
3. Type in the profile info as instructed by your company IT administrator or VPN service.

Edit a VPN profile

1. Tap  next to a profile name.
2. Change the info as required.

Delete a VPN profile

1. Tap  next to a profile name.
2. Tap **FORGET**.

7 Organize your day

DATE AND TIME

Set date and time

Tap **Settings** > **System** > **Date & time**.

Update the time and date automatically

You can set your phone to update the time, date, and time zone automatically. Automatic update is a network service and may not be available depending on your region or network service provider.

1. Tap **Settings** > **System** > **Date & time**.
2. Switch **Use network-provided time** on.
3. Switch **Use network-provided time zone** on.

Change the clock to the 24-hour format

Tap **Settings** > **System** > **Date & time**, and switch **Use 24-hour format** on.

ALARM CLOCK

Set an alarm

1. Tap **Clock** > **Alarm**.
2. To add an alarm, tap **+**.
3. To modify an alarm, tap it. To set the alarm to repeat on specific dates, check **Repeat** and highlight the days of the week.

Switch an alarm off

When the alarm sounds, swipe the alarm right.

CALENDAR

Manage calendars

Tap **Calendar** > ≡, and select what type of calendar you want to see.

Calendars are added automatically when you add an account to your phone. To add a new account with a calendar, go to the apps menu and tap **Settings** > **Accounts** > **Add account**.

Add an event

1. Tap **Calendar** > +. often the event should repeat.
2. Type in the details you want, and set the time.
3. To make the event repeat on certain days, tap **Does not repeat**, and select how
4. To set a reminder, tap **Add notification**, set the time and tap **Done**.
5. Tap **Save**.



Tip: To edit an event, tap the event and , and edit the details.

Delete an appointment

1. Tap the event.
2. Tap **:** > **Delete**.

8 Maps

FIND PLACES AND GET DIRECTIONS

Find a spot

Google Maps helps you find specific locations and businesses.

1. Tap **Maps**.
2. Write search words, such as a street address or place name, in the search bar.
3. Select an item from the list of proposed matches as you write, or tap  to search.

The location is shown on the map. If no search results are found, make sure the spelling of your search words is correct.

See your current location

Tap **Maps** > .

Get directions to a place

1. Tap **Maps** and enter your destination in the search bar.
2. Tap **Directions**. The highlighted icon shows the mode of transportation, for example . To change the mode, select the new mode under the search bar.
3. If you don't want the starting point to be your current location, tap **Your location**, and search for a new starting point.
4. Tap **NAVIGATE IN APP** to start the navigation.

The route is shown on the map, along with an estimate of how long it takes to get there. To see detailed directions, tap **Steps**.

9 Apps, updates, and backups

GET APPS FROM GOOGLE PLAY

You need to have a Google account added to your phone to use Google Play services. Charges may apply to some of the content available in Google Play. To add a payment method, tap **Play Store**, tap your Google logo on the search field, and then tap **Payment methods**. Always be sure to have a permission from the payment method owner when buying content from Google Play.

Add a Google account to your phone

1. Tap **Settings** > **Accounts** > **Add account** > **Google**. If asked, confirm your device lock method.
2. Type in your Google account credentials and tap **Next**, or, to create a new account, tap **Create account**.
3. Follow the instructions on your phone.

Download apps

1. Tap **Play Store**.
2. Tap the search bar to look for apps, or select apps from your recommendations.
3. In the app description, tap **Install** to download and install the app.

To see your apps, go to the home screen and swipe up from the bottom of the screen.

FREE UP SPACE ON YOUR PHONE

If your phone memory is getting full, move files to a memory card or delete unnecessary files.

Transfer files to a memory card

To move photos from your phone memory to a memory card, tap **Files** > **Images**. Press and hold the photo you want to move, and tap **⋮** > **Move to** > **SD card**.

To move documents and files, tap **Files** > **Documents & Other**. Tap **⋮** next to the file name, and tap **Move to SD card**.

UPDATE YOUR PHONE SOFTWARE

Stay in step with the beat – update your phone software and apps wirelessly to get new and enhanced features for your phone. Updating the software may also improve your phone performance.

Install available updates

Tap **Settings** > **System** > **Advanced** > **System update** > **Check for update** to check if updates are available.

When your phone notifies you that an update is available, just follow the instructions shown on your phone. If your phone is low on memory, you may need to move your photos and other stuff to the memory card.

Warning: If you install a software update, you cannot use the device, even to make emergency calls, until the installation is completed and the device is restarted.

Before starting the update, connect a charger or make sure the device battery has enough power, and connect to Wi-Fi, as the update packages may use up a lot of mobile data.

BACK UP YOUR DATA

To ensure your data is safe, use the backup feature in your phone. Your device data (such as Wi-Fi passwords and call history) and app data (such as settings and files stored by apps) will be backed up remotely.

Switch on automatic backup

Tap **Settings** > **System** > **Backup**, and switch back up on.

RESTORE ORIGINAL SETTINGS AND REMOVE PRIVATE CONTENT FROM YOUR PHONE

Accidents can happen – if your phone is not working properly, you can restore its settings. Or, if you buy a new phone, or otherwise want to dispose of or recycle your phone, here's how you can remove your personal info and content. Note that it is your responsibility to remove all private content.

Reset your phone

1. Tap **Settings** > **System** > **Advanced** > **Reset options** > **Erase all data (factory reset)**.
2. Follow the instructions shown on your phone.

10 Protect your phone

PROTECT YOUR PHONE WITH A SCREEN LOCK

You can set your phone to require authentication when unlocking the screen.

Set a screen lock

1. Tap **Settings** > **Security** > **Screen lock**.
2. Choose the type of lock and follow the instructions on your phone.

PROTECT YOUR PHONE WITH YOUR FACE

Set up face authentication

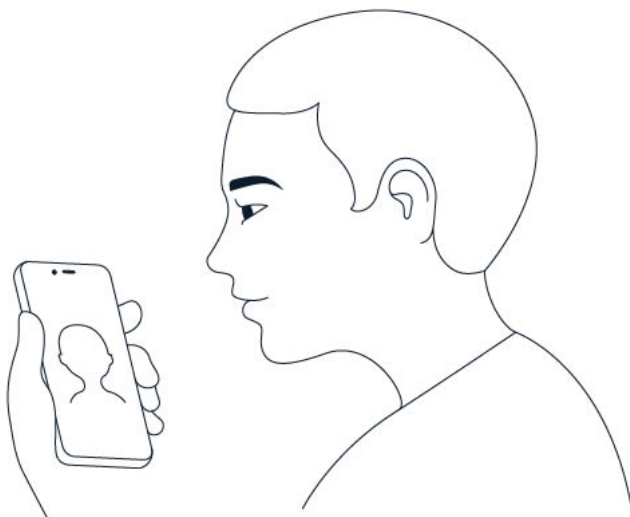

1. Tap **Settings** > **Security** > **Face unlock**.
2. Select what backup unlocking method you want to use for the lock screen and follow the instructions shown on your phone.

Keep your eyes open and make sure your face is fully visible and not covered by any object, such as a hat or sunglasses.

Note: Using your face to unlock your phone is less secure than using a pattern or a password. Your phone may be unlocked by someone or something with similar appearance. Face unlock may not work properly in backlight or too dark or bright environment.

Unlock your phone with your face

To unlock your phone, just turn your screen on and look at the camera.

If there is a facial recognition error, and you cannot use alternative sign-in methods to recover or reset the phone in any way, your phone will require service. Additional charges may apply, and all the personal data on your phone may be deleted. For more info, contact the nearest authorized service facility for your phone, or your phone dealer.

CHANGE YOUR SIM PIN CODE

If your SIM card came with a pre-set PIN code, you can change it to something more secure. Not all network service providers support this.

Select your SIM PIN code

You can choose which digits to use for the SIM PIN. The SIM PIN code can be 4-8 digits.

1. Tap **Settings** > **Security** > **SIM card lock**.
2. Under the selected SIM card, tap **Change SIM PIN**.

ACCESS CODES

Learn what the different codes on your phone are for.

PIN or PIN2 code

PIN or PIN2 codes have 4-8 digits.

These codes protect your SIM card against unauthorized use or are required to access some features. You can set your phone to ask for the PIN code when you switch it on.

If you forget the codes or they aren't supplied with your card, contact your network service provider.

If you type in the code incorrectly 3 times in a row, you need to unblock the code with the PUK or PUK2 code.

PUK or PUK2 codes

PUK or PUK2 codes are required to unblock a PIN or PIN2 code.

If the codes are not supplied with your SIM card, contact your network service provider.

Lock code

Lock code is also known as security code or password.

The lock code helps you protect your phone against unauthorized use. You can set your phone to ask for the lock code that you define. Keep the code secret and in a safe place, separate from your phone.

If you forget the code and your phone is locked, your phone will require service. Additional charges may apply, and all the personal data on your phone may be deleted. For more info, contact the nearest authorized service facility for your phone, or your phone dealer.

IMEI code

The IMEI code is used to identify phones in the network. You may also need to give the number to your authorized service facility or phone dealer. To view your IMEI code:

- dial *#06#
- check the original sales box

If the IMEI code is printed on your phone, you may find it, for example, on the SIM tray or under the back cover, if your phone has a removable cover.

Locate or lock your phone

If you lose your phone, you may be able to find, lock, or erase it remotely if you have signed in to a Google Account. Find My Device is on by default for phones associated with a Google Account.

To use Find My Device, your lost phone must be:

- Turned on
- Signed in to a Google Account
- Connected to mobile data or Wi-Fi
- Visible on Google Play
- Location turned on
- Find My Device turned on

When Find My Device connects with your phone, you see the phone's location, and the phone gets a notification.

1. Open android.com/find on a computer, tablet or phone connected to the internet and sign in to your Google Account.
2. If you have more than one phone, click the lost phone at the top of the screen.
3. On the map, see about where the phone is. The location is approximate and may not be accurate.

If your device can't be found, Find My Device will show its last known location, if available. To lock or erase your phone, follow the instructions on the web site.

11 Product and safety information

FOR YOUR SAFETY

Read these simple guidelines. Not following them may be dangerous or against local laws and regulations. For further info, read the complete user guide.

SWITCH OFF IN RESTRICTED AREAS



Switch the device off when mobile device use is not allowed or when it may cause interference or danger, for example, in aircraft, in hospitals or near medical equipment, fuel, chemicals, or blasting areas. Obey all instructions in restricted areas.

ROAD SAFETY COMES FIRST



Obey all local laws. Always keep your hands free to operate the vehicle while driving. Your first consideration while driving should be road safety.

INTERFERENCE



All wireless devices may be susceptible to interference, which could affect performance.

AUTHORIZED SERVICE



Only authorized personnel may install or repair this product.

BATTERIES, CHARGERS, AND OTHER ACCESSORIES



Use only batteries, chargers, and other accessories approved by HMD Global Oy for use with this device. Do not connect incompatible products.

KEEP YOUR DEVICE DRY



If your device is water-resistant, see its IP rating in the device's technical specifications for more detailed guidance.

GLASS PARTS



The device and/or its screen is made of glass. This glass can break if the device is dropped on a hard surface or receives a substantial impact. If the glass breaks, do not touch the glass parts of the device or attempt to remove the broken glass from the device. Stop using the device until the glass is replaced by authorized service personnel.

PROTECT YOUR HEARING



To prevent possible hearing damage, do not listen at high volume levels for long periods. Exercise caution when holding your device near your ear while the loudspeaker is in use.

SAR



This device meets RF exposure guidelines when used either in the normal use position against the ear or when positioned at least 1.5 centimetres (5/8 inch) away from the body. The specific maximum SAR values can be found in the Certification Information (SAR) section of this user guide. For more information, see the Certification Information (SAR) section of this user guide or go to www.sar-tick.com.

NETWORK SERVICES AND COSTS

Using some features and services, or downloading content, including free items, require a network connection. This may cause the transfer of large amounts of data, which may result in data costs. You may also need to subscribe to some features.

EMERGENCY CALLS

 **Important:** Connections in all conditions cannot be guaranteed. Never rely solely on any wireless phone for essential communications like medical emergencies.

Before making the call:

- Switch the phone on.
- If the phone screen and keys are locked, unlock them.
- Move to a place with adequate signal strength.

On the home screen, tap .

1. Type in the official emergency number for your present location. Emergency call numbers vary by location.
2. Tap .
3. Give the necessary info as accurately as possible. Do not end the call until given permission to do so.

You may also need to do the following:

- Put a SIM card in the phone. If you don't have a SIM card, on the lock screen, tap **Emergency**.
- If your phone asks for a PIN code, tap **Emergency**.
- Switch the call restrictions off in your phone, such as call barring, fixed dialling, or closed user group.
- If the mobile network is not available, you may also try making an internet call, if you can access the internet.

TAKE CARE OF YOUR DEVICE

Handle your device, battery, charger and accessories with care. The following suggestions help you keep your device operational.

- Keep the device dry. Precipitation, humidity, and all types of liquids or moisture can contain minerals that corrode electronic circuits.
- Do not use or store the device in dusty or dirty areas.
- Do not store the device in high temperatures. High temperatures may damage the device or battery.
- Do not store the device in cold temperatures. When the device warms to its normal temperature, moisture can form inside the device and damage it.
- Do not open the device other than as instructed in the user guide.
- Unauthorized modifications may damage the device and violate regulations governing radio devices.
- Do not drop, knock, or shake the device or the battery. Rough handling can break it.
- Only use a soft, clean, dry cloth to clean the surface of the device.
- Do not paint the device. Paint can prevent proper operation.
- Keep the device away from magnets or magnetic fields.
- To keep your important data safe, store it in at least two separate places, such as your device, memory card, or computer, or write down important info.

During extended operation, the device may feel warm. In most cases, this is normal. To avoid getting too warm, the device may automatically slow down, dim display during a video call, close apps, switch off charging, and if necessary, switch itself off. If the device is not working properly, take it to the nearest authorized service facility.

RECYCLE



Always return your used electronic products, batteries, and packaging materials to dedicated collection points. This way you help prevent uncontrolled waste disposal and promote the recycling of materials. Electrical and electronic products contain a lot of valuable materials, including metals (such as copper, aluminum, steel, and magnesium) and precious metals (such as gold, silver, and palladium). All materials of the device can be recovered as materials and energy.

CROSSED-OUT WHEELIE BIN SYMBOL

Crossed-out wheelie bin symbol



The crossed-out wheelie-bin symbol on your product, battery, literature, or packaging reminds you that all electrical and electronic products and batteries must be taken to separate collection at the end of their working life. Remember to remove personal data from the device first. Do not dispose of these products as unsorted municipal waste: take them for recycling. For info on your nearest recycling point, check with your local waste authority, or read about HMD's take-back program and its availability in your country at www.hmd.com/phones/support/topics/recycle.

BATTERY AND CHARGER INFORMATION

Battery and charger info

To check if your phone has a removable or non-removable battery, see the printed guide.

Devices with a removable battery Use your device only with an original rechargeable battery. The battery can be charged and discharged hundreds of times, but it will eventually wear out. When the talk and standby times are noticeably shorter than normal, replace the battery.

Devices with a non-removable battery Do not attempt to remove the battery, as you may damage the device. The battery can be charged and discharged hundreds of times, but it will eventually wear out. When the talk and standby times are noticeably shorter than normal, to replace the battery, take the device to the nearest authorized service facility.

Charge your device with a compatible charger. Charger plug type may vary. Charging time can vary depending on device capability.

Battery and charger safety info

Once charging of your device is complete, unplug the charger from the device and electrical outlet. Please note that continuous charging should not exceed 12 hours. If left unused, a fully charged battery will lose its charge over time.

Extreme temperatures reduce the capacity and lifetime of the battery. Always keep the battery between 15°C and 25°C (59°F and 77°F) for optimal performance. A device with a

hot or cold battery may not work temporarily. Note that the battery may drain quickly in cold temperatures and lose enough power to switch off the phone within minutes. When you are outdoors in cold temperatures, keep your phone warm.

Obey local regulations. Recycle when possible. Do not dispose as household waste.

Do not expose the battery to extremely low air pressure or leave it to extremely high temperature, for example dispose it in a fire, as that may cause the battery to explode or leak flammable liquid or gas.

Do not dismantle, cut, crush, bend, puncture, or otherwise damage the battery in any way. If a battery leaks, do not let liquid touch skin or eyes. If this happens, immediately flush the affected areas with water, or seek medical help. Do not modify, attempt to insert foreign objects into the battery, or immerse or expose it to water or other liquids. Batteries may explode if damaged.

Use the battery and charger for their intended purposes only. Improper use, or use of unapproved or incompatible batteries or chargers may present a risk of fire, explosion, or other hazard, and may invalidate any approval or warranty. If you believe the battery or charger is damaged, take it to a service centre or your phone dealer before continuing to use it. Never use a damaged battery or charger. Only use the charger indoors. Do not charge your device during a lightning storm. When charger is not included in the sales pack, charge your device using the data cable (included) and a USB power adaptor (may be sold separately). You can charge your device with third-party cables and power adaptors that are compliant with USB 2.0 or later and with applicable country regulations and international and regional safety standards. Other adaptors may not meet applicable safety standards, and charging with such adaptors could pose a risk of property loss or personal injury.

To unplug a charger or an accessory, hold and pull the plug, not the cord.

Additionally, the following applies if your device has a removable battery:

- Always switch the device off and unplug the charger before removing any covers or the battery.
- Accidental short-circuiting can happen when a metallic object touches the metal strips on the battery. This may damage the battery or the other object.

SMALL CHILDREN

Your device and its accessories are not toys. They may contain small parts. Keep them out of the reach of small children.

MEDICAL DEVICES

Operation of radio transmitting equipment, including wireless phones, may interfere with inadequately shielded medical devices' function. Consult a physician or the medical device's manufacturer to determine if it is adequately shielded from external radio energy.

IMPLANTED MEDICAL DEVICES

To avoid potential interference, manufacturers of implanted medical devices (such as cardiac pacemakers, insulin pumps, and neurostimulators) recommend a minimum separation of 15.3 centimeters (6 inches) between a wireless device and the medical device. Persons who have such devices should:

- Always keep the wireless device more than 15.3 centimeters (6 inches) from the medical device.
- Not carry the wireless device in a breast pocket.
- Hold the wireless device to the ear opposite the medical device.
- Switch the wireless device off if there is any reason to suspect that interference is taking place.
- Follow the manufacturer directions for the implanted medical device.

If you have any questions about using your wireless device with an implanted medical device, consult your health care provider.

HEARING



Warning: When you use the headset, your ability to hear outside sounds may be affected. Do not use the headset where it can endanger your safety.

Some wireless devices may interfere with some hearing aids.

PROTECT YOUR DEVICE FROM HARMFUL CONTENT

Your device may be exposed to viruses and other harmful content. Take the following precautions:

- Be cautious when opening messages. They may contain malicious software or otherwise be harmful to your device or computer.
- Be cautious when accepting connectivity requests, browsing the internet, or downloading content. Do not accept Bluetooth connections from sources you do not trust.
- Only install and use services and software from sources that you trust and that offer adequate security and protection.
- Install antivirus and other security software on your device and any connected computer. Only use one antivirus app at a time. Using more may affect performance and operation of the device and/or computer.
- If you access preinstalled bookmarks and links to third party internet sites, take the appropriate precautions. HMD Global does not endorse or assume liability for such sites.

VEHICLES

Radio signals may affect improperly installed or inadequately shielded electronic systems in vehicles. For more info, check with the manufacturer of your vehicle or its equipment. Only authorized personnel should install the device in a vehicle. Faulty installation may be dangerous and invalidate your warranty. Check regularly that all wireless device equipment in your vehicle is mounted and operating properly. Do not store or carry flammable or explosive materials in the same compartment as the device, its parts, or accessories. Do not place your device or accessories in the air bag deployment area.

POTENTIALLY EXPLOSIVE ENVIRONMENTS

Switch your device off in potentially explosive environments, such as near gasoline pumps. Sparks may cause an explosion or fire resulting in injury or death. Note restrictions in areas with fuel; chemical plants; or where blasting operations are in progress. Areas with a potentially explosive environment may not be clearly marked. These usually are areas where you are advised to switch your engine off, below deck on boats, chemical transfer or storage facilities, and where the air contains chemicals or particles. Check with the manufacturers of vehicles using liquefied petroleum gas (such as propane or butane) if this device can be safely used in their vicinity.

CERTIFICATION INFORMATION

This mobile device meets guidelines for exposure to radio waves.

Your mobile device is a radio transmitter and receiver. It is designed not to exceed the limits for exposure to radio waves (radio frequency electromagnetic fields), recommended by international guidelines from the independent scientific organization ICNIRP. These guidelines incorporate substantial safety margins that are intended to assure the protection of all persons regardless of age and health. The exposure guidelines are based on the Specific Absorption Rate (SAR), which is an expression of the amount of radio frequency (RF) power deposited in the head or body when the device is transmitting. The ICNIRP SAR limit for mobile devices is 2.0 W/kg averaged over 10 grams of tissue.

SAR tests are carried out with the device in standard operating positions, transmitting at its highest certified power level, in all its frequency bands.

This device meets RF exposure guidelines when used against the head or when positioned at least 5/8 inch (1.5 centimetres) away from the body. When a carry case, belt clip or other form of device holder is used for body-worn operation, it should not contain metal and should provide at least the above stated separation distance from the body.

To send data or messages, a good connection to the network is needed. Sending may be delayed until such a connection is available. Follow the separation distance instructions until the sending is finished.

During general use, the SAR values are usually well below the values stated above. This is because, for purposes of system efficiency and to minimize interference on the network,

the operating power of your mobile device is automatically decreased when full power is not needed for the call. The lower the power output, the lower the SAR value.

Device models may have different versions and more than one value. Component and design changes may occur over time and some changes could affect SAR values.

For more info, go to www.sar-tick.com. Note that mobile devices may be transmitting even if you are not making a voice call.

The World Health Organization (WHO) has stated that current scientific information does not indicate the need for any special precautions when using mobile devices. If you are interested in reducing your exposure, they recommend you limit your usage or use a hands-free kit to keep the device away from your head and body. For more information and explanations and discussions on RF exposure, go to the WHO website at www.who.int/health-topics/electromagnetic-fields#tab=tab_1.

Please refer to www.hmd.com/sar for the maximum SAR value of the device.

ABOUT DIGITAL RIGHTS MANAGEMENT

When using this device, obey all laws and respect local customs, privacy and legitimate rights of others, including copyrights. Copyright protection may prevent you from copying, modifying, or transferring photos, music, and other content.

COPYRIGHTS AND OTHER NOTICES

Copyrights and other notices

The availability of some products, features, applications and services described in this guide may vary by region and require activation, sign up, network and/or internet connectivity and an appropriate service plan. For more info, contact your dealer or your service provider. This device may contain commodities, technology or software subject to export laws and regulations from the US and other countries. Diversion contrary to law is prohibited.

The contents of this document are provided "as is". Except as required by applicable law, no warranties of any kind, either express or implied, including, but not limited to, the implied warranties of merchantability and fitness for a particular purpose, are made in relation to the accuracy, reliability or contents of this document. HMD Global reserves the right to revise this document or withdraw it at any time without prior notice.

To the maximum extent permitted by applicable law, under no circumstances shall HMD Global or any of its licensors be responsible for any loss of data or income or any special, incidental, consequential or indirect damages howsoever caused.

Reproduction, transfer or distribution of part or all of the contents in this document in any form without the prior written permission of HMD Global is prohibited. HMD Global operates a policy of continuous development. HMD Global reserves the right to make changes and improvements to any of the products described in this document without prior notice.

HMD Global does not make any representations, provide a warranty, or take any responsibility for the functionality, content, or end-user support of third-party apps provided with your device. By using an app, you acknowledge that the app is provided as is.

Downloading of maps, games, music and videos and uploading of images and videos may involve transferring large amounts of data. Your service provider may charge for the data transmission. The availability of particular products, services and features may vary by region. Please check with your local dealer for further details and availability of language options.

Certain features, functionality and product specifications may be network dependent and subject to additional terms, conditions, and charges.

All specifications, features and other product information provided are subject to change without notice.

HMD Global Privacy Policy, available at <http://www.hmd.com/privacy>, applies to your use of the device.

HMD Global Oy is the exclusive licensee of the Nokia brand for phones & tablets. Nokia is a registered trademark of Nokia Corporation.

Android, Google and other related marks and logos are trademarks of Google LLC.

The Bluetooth word mark and logos are owned by the Bluetooth SIG, Inc. and any use of such marks by HMD Global is under license.