

NOKIA

Nokia 3310 3G

User Guide

Table of Contents

1	About this user guide	5
2	Get started	6
	Keys and parts	6
	Set up and switch on your phone	7
	Charge your phone	10
	Lock or unlock the keys	11
3	Basics	12
	Get the most out of the two SIM cards (dual SIM phones)	12
	Explore your phone	13
	Change the volume	16
	Write text	16
4	Calls, contacts, and messages	18
	Calls	18
	Contacts	19
	Send and receive messages	20
5	Personalize your phone	21
	Change your ring or message tone	21
	Change the look of your home screen	21
6	Camera	23
	Photos	23
	Videos	24
7	Internet and connections	25
	Browse the web	25

8 Music, audio and videos	26
Music player	26
Voice recorder	26
Video player	26
9 Radio	28
Find and save radio stations	28
Listen to radio	28
10 Clock, calendar, and calculator	29
Set the time and date manually	29
Alarm clock	29
Calendar	29
Calculator	30
11 Bluetooth	31
Activate Bluetooth	31
12 Copy, share and remove content	32
Copy content	32
Share content	32
Memory	33
Remove private content from your phone	33
13 Backup and restore	34
Create a backup	34
Restore a backup	34
14 Tools	35
Extras	35
Torch	35
Counters	36

15 Settings	37
System settings	37
Connectivity settings	38
Personalization settings	38
Time and language settings	39
Security settings	40
16 Product and safety information	41
For your safety	41
Network services and costs	43
Emergency calls	43
Take care of your device	44
Recycle	45
Crossed-out wheelie bin symbol	45
Battery and charger information	46
Small children	46
Medical devices	47
Implanted medical devices	47
Hearing	47
Protect your device from harmful content	47
Vehicles	48
Potentially explosive environments	48
Certification information	48
Copyrights and other notices	49
About Digital Rights Management	50

1 About this user guide



Important: For important information on the safe use of your device and battery, read “Product and safety information” before you take the device into use. To find out how to get started with your new device, read the user guide.

2 Get started

KEYS AND PARTS

Explore the keys and parts of your new phone.

Your phone

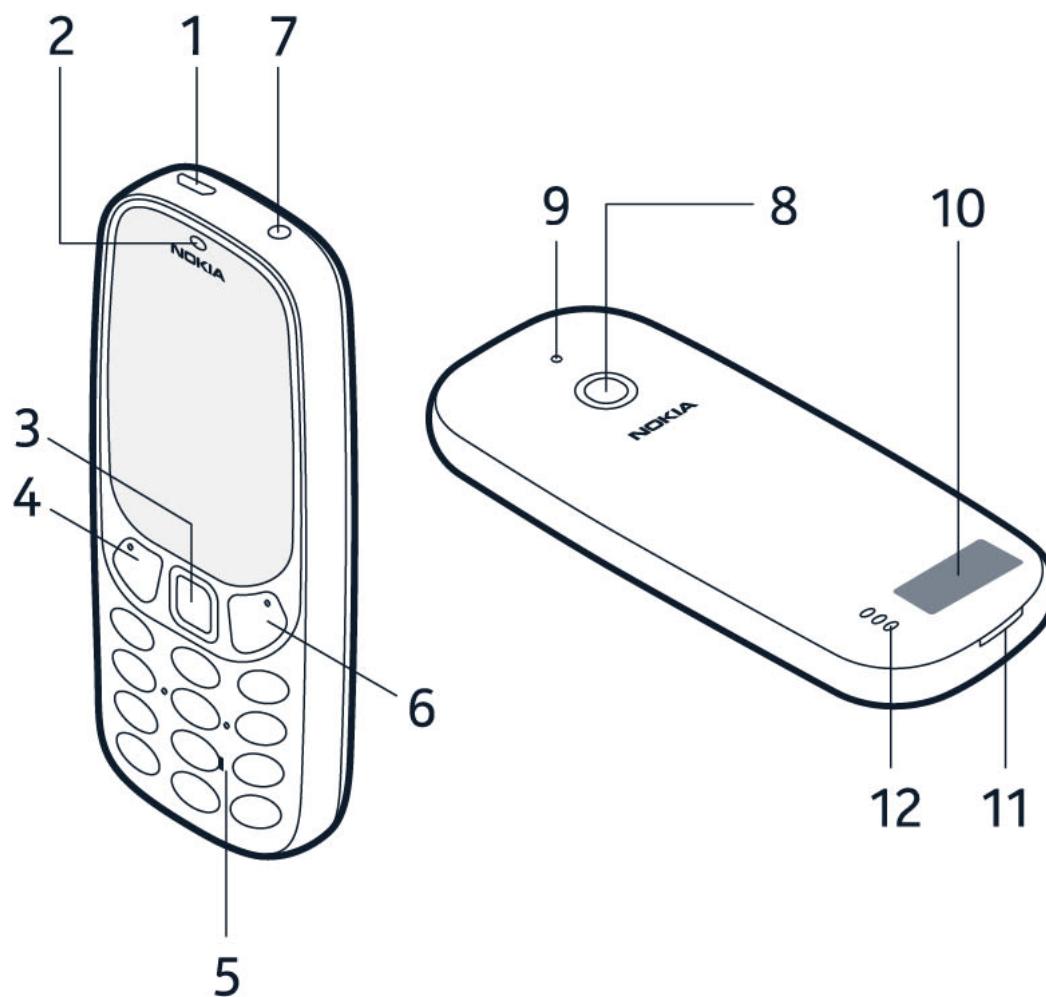

The keys and parts of your phone are:

- | | |
|-----------------------------|-------------------------------------|
| 1. Charger connector | 6. Function key, end call/power key |
| 2. Earpiece | 7. Headphone connector |
| 3. Scroll and selection key | 8. Camera |
| 4. Function key, call key | 9. Flash light |
| 5. Number keys | 10. Antenna area |

11. Back cover opening slot

12. Loudspeaker

To lock the keys automatically, select **Menu** >  > **Security** > **Keyguard** > **Automatic keyguard** and select **On**.



To unlock the keys, select **Unlock** and press *****.

Avoid touching the antenna area while the antenna is in use. Contact with antennas affects the communication quality and may reduce battery life due to higher power level during operation.

Do not connect to products that create an output signal, as this may damage the device. Do not connect any voltage source to the audio connector. If you connect an external device or headset, other than those approved for use with this device, to the audio connector, pay special attention to volume levels.

Parts of the device are magnetic. Metallic materials may be attracted to the device. Do not place credit cards or other magnetic storage media near the device, because info stored on them may be erased.

Some of the accessories mentioned in this user guide, such as charger, headset, or data cable, may be sold separately.

 **Note:** You can set the phone to ask for a security code. Select **Menu** >  > **Security** > **Keyguard** and set **Security code** on. If there is a pre-set code, it is 12345. Change it to protect your privacy and personal data. Note, however, that when you change the code, you need to remember the new code, as HMD Global is not able to open or bypass it. This phone cannot be located or locked remotely if lost.

SET UP AND SWITCH ON YOUR PHONE

Learn how to insert the SIM card, memory card, and battery, and how to switch on your phone.

Micro SIM



Important: This device is designed to be used with a micro SIM card (see figure) only. Use of incompatible SIM cards may damage the card or the device, and may corrupt data stored on the card. Please consult your mobile operator for the use of a SIM card that has a nano-UICC cutout.

MicroSD memory cards



Use only compatible memory cards approved for use with this device. Incompatible cards may damage the card and the device and corrupt data stored on the card.



Note: Switch the device off and disconnect the charger and any other device before removing any covers. Avoid touching electronic components while changing any covers. Always store and use the device with any covers attached.

Set up your phone (single SIM)



1. Place your fingernail in the small slot at the bottom of the phone, lift and remove the cover.
2. If the battery is in the phone, lift it out.
3. Slide the SIM into the SIM slot with the contact area face down.
4. If you have a memory card, slide the memory card into the memory card slot.
5. Line up the battery contacts, and put the battery in.
6. Put back the back cover.

Set up your phone (dual SIM)

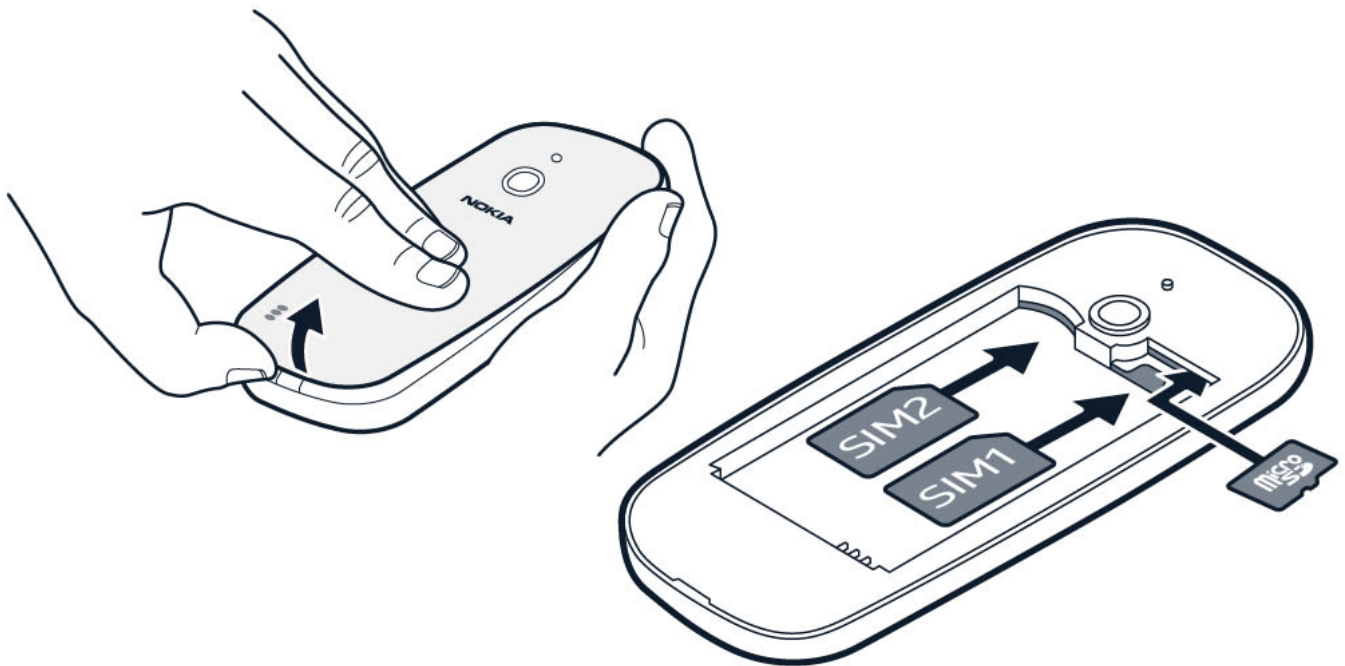

1. Place your fingernail in the small slot at the bottom of the phone, lift and remove the cover.
2. If the battery is in the phone, lift it out.
3. Slide the first SIM into SIM slot 1 with the contact area face down. Slide the second SIM into SIM slot 2. Both SIM cards are available at the same time when the device is not being used, but while one SIM card is active, for example, making a call, the other may be unavailable.
4. If you have a memory card, slide the memory card into the memory card slot.
5. Line up the battery contacts, and put the battery in.
6. Put back the back cover.

Switch on your phone

Press and hold the  key.

Remove the SIM card

Open the back cover, remove the battery, and slide the SIM out.

Remove the memory card

Open the back cover, remove the battery, and pull the memory card out.

Access codes

Your phone and SIM card use different codes for security.

- PIN or PIN2 codes: These codes protect your SIM card against unauthorized use. If you forget the codes or they aren't supplied with your card, contact your network service provider. If you type in the code incorrectly 3 times in a row, you need to unblock the code with the PUK or PUK2 code.
- PUK or PUK2 codes: These codes are required to unblock a PIN or PIN2 code. If the codes are not supplied with your SIM card, contact your network service provider.
- Security code: The security code helps you protect your phone against unauthorized use. You can set your phone to ask for the security code that you define. Keep the code secret and in a safe place, separate from your phone. If you forget the code and your phone is locked, your phone will require service. Additional charges may apply, and all the personal data on your phone may be deleted. For more info, contact the nearest care point for your phone, or your phone dealer.
- IMEI code: The IMEI code is used to identify phones in the network. You may also need to give the number to your care point services or phone dealer. To view your IMEI number, dial `*#06#`. Your phone's IMEI code is also printed on your phone label, which is located under the battery. The IMEI is also visible on the original sales box.

CHARGE YOUR PHONE

Your battery has been partially charged at the factory, but you may need to recharge it before you can use your phone.

Charge the battery

1. Plug the charger into a wall outlet.
2. Connect the charger to the phone. When done, unplug the charger from the phone, then from the wall outlet.

If the battery is completely discharged, it may take several minutes before the charging indicator is displayed.



Tip: You can use USB charging when a wall outlet is not available. Data can be transferred while charging the device. The efficiency of USB charging power varies significantly, and it may take a long time for charging to start and the device to start functioning. Make sure your computer is switched on.

Save power

To save power:

1. Charge wisely: always charge the battery fully.
2. Select only the sounds that you need: mute unnecessary sounds, such as keypad sounds.
3. Use wired headphones, rather than the loudspeaker.
4. Change the phone screen settings: set the phone screen to switch off after a short time.
5. Lower the screen brightness.
6. When applicable, use network connections, such as Bluetooth, selectively: switch the connections on only when you are using them.

LOCK OR UNLOCK THE KEYS

Lock the keypad

To lock the keys automatically, select **Menu** >  > **Security** > **Keyguard** > **Automatic keyguard** and select **On**.

Unlock the keypad

To unlock the keys, select **Unlock** and press *****.

3 Basics

GET THE MOST OUT OF THE TWO SIM CARDS (DUAL SIM PHONES)

Your phone can use two SIM cards, and you can use them for different purposes.

Select which SIM card to use

1. Select **Menu** >  > **Connectivity** > **Dual SIM**.
2. To choose which SIM to use for calls, select **Preferred SIM for calls**, and select **SIM1** or **SIM2**.
3. To choose which SIM to use for messages, select **Preferred SIM for messages**, and select **SIM1** or **SIM2**.
4. To choose which SIM to use for mobile data, select **Mobile data connection**, switch **Mobile data** on, and select either **SIM1** or **SIM2**.

Forward calls between your 2 SIMs

Get the most out of your 2 SIM cards. If you forward your calls between your SIMs, when someone calls you on one SIM while you're having a call on the other, you can manage your calls from both SIMs just like with only one SIM.

Make sure you have 2 SIM cards inserted in your phone.

1. Select **Menu** >  > **Connectivity** > **Dual SIM** > **SIM numbers**.
2. Type in the numbers of your both SIMs and select **Save**.
3. Scroll up to **Forward calls**, and select **Between two SIMs**, **From SIM1 to SIM2**, or **From SIM2 to SIM1**.

EXPLORE YOUR PHONE

See the apps and features of your phone



Select **Menu**.

Go to an app or feature

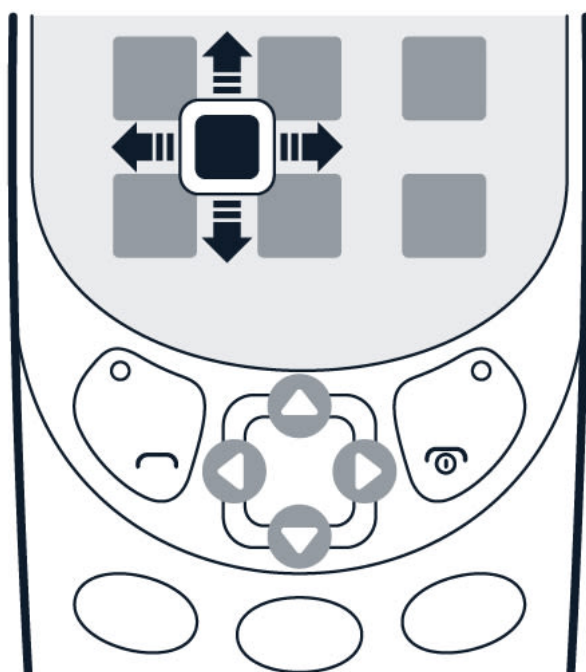

Press the scroll key up, down, left, or right.

Open an app or select a feature



Select **Select**.

Go back to the previous view

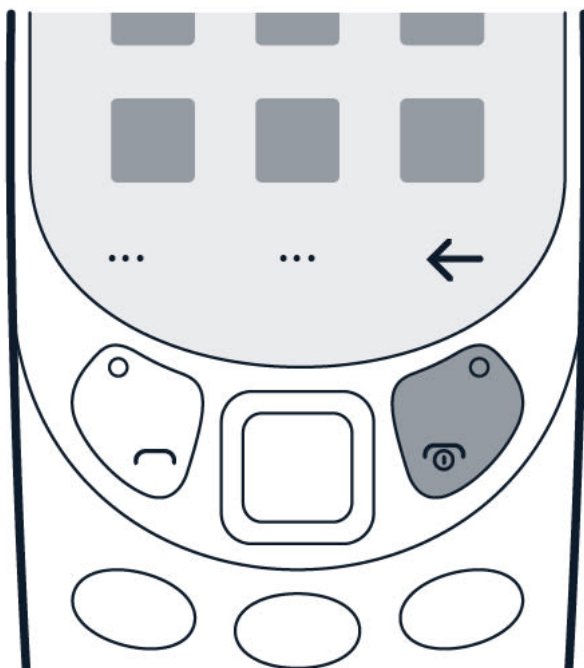

Press ←.

Go back to the home screen

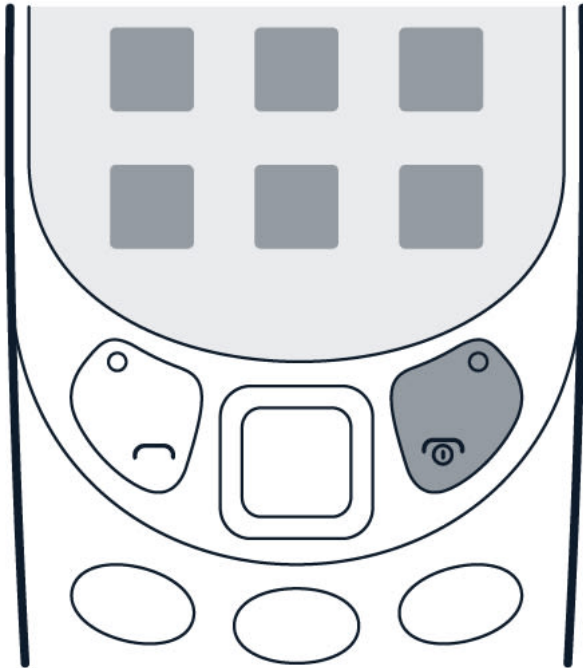

Press the end key.

Arrange the menu

If you want to change the order of applications in the menu, you can rearrange them.

To rearrange the menu, select the application that you want to move. Select **Menu** > ≡ > **Move**, and use the scroll key to move the application. Press the scroll key to place the application to your desired location.

CHANGE THE VOLUME

Turn the volume up or down

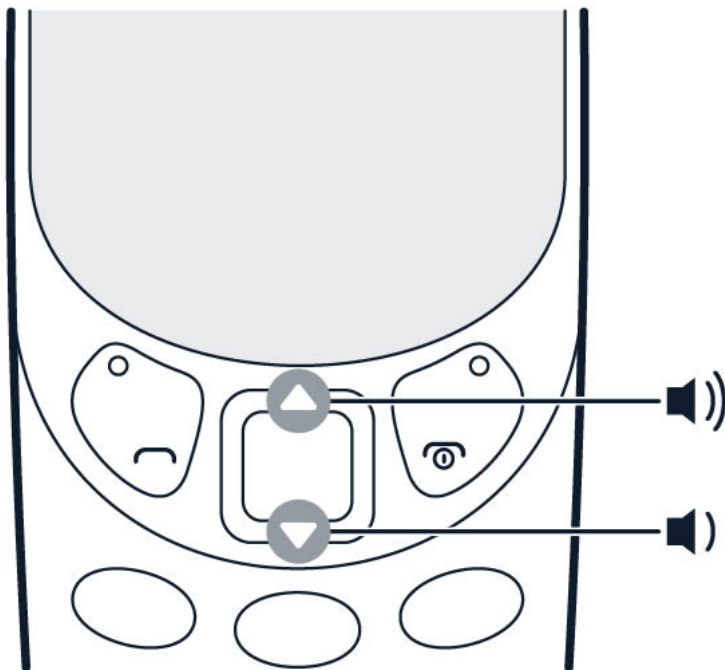

Trouble hearing your phone ringing in noisy environments, or calls too loud? You can change the volume to your liking.

Scroll up or down to change the volume during a call or when listening to the radio.

WRITE TEXT

Write using the keypad

Writing with the keypad is easy and fun.

Press a key repeatedly until the letter is shown.

To type in a space press **0**.



To type in a special character or punctuation mark, press *****.

To switch between character cases, press **#** repeatedly.



To type in a number, press and hold a number key.

Use predictive text

To speed up your writing, your phone can guess what you are starting to write. Predictive text is based on a built-in dictionary. This feature is not available for all languages.

To switch predictive text on, select **Menu** >  > . Scroll to **Predictive text** and select a language.

To switch between predictive and traditional text, press **#** repeatedly.

To switch predictive text off, select **Menu** >  > , scroll to **Predictive text**, and select **Predictive text off**.

4 Calls, contacts, and messages

CALLS

Make a call

Learn how to make a call with your new phone.

1. Type in the phone number. To type in the + character, used for international calls, press * twice.
2. Press the call key. If asked, select which SIM to use.
3. To end the call, press the end key.

Answer a call

Press .





Tip: To handle your calls hands-free, pair your phone with a compatible Bluetooth headset (sold separately). To switch Bluetooth on, select **Menu** >  > **Connectivity** > **Bluetooth**, and switch **Bluetooth** to **On**.



Tip: If you are in a situation where you cannot answer the phone and you need to silence it quickly, press .

Speed dial

You can call a contact quickly using speed dial.



1. To add people to your speed dial list, select **Menu** > .
2. Select  > **Speed dial** and switch **Speed dial** on.
3. Select **Edit**.
4. Scroll to an available speed dial number, and select **Add**.
5. Select a contact.



You can select whether the phone calls or sends a text message when you press the speed dial key. By default, the phone calls. To change the call to a text message, select the speed dial and  > **Send message**.



CONTACTS



Add a contact

Save and organize your friends' phone numbers.

1. Select **Menu** >  >  > **Add new contact**.
2. Scroll up to add a photo for the contact.
3. Scroll down to write the name and number and to add any other information that you want to include. You can also select a specific ringtone for the contact.
4. Select  > **Save contact**.



 **Tip:** You can select which memory you want to use for storing contacts. Select **Options** >  > **Storage** > **Preferred storage** and select **Phone** or **Memory card**.

 **Tip:** To save a phone number in the dialer, type in the number, and select  > **Add to Contacts** and select whether to create a new contact or to update existing.

 **Tip:** To copy contacts between your phone and SIM cards, in **Contacts**, select  > **Copy contacts**.

Save a contact from call log

You can save contacts from call log.

1. Select **Menu** > .
2. Highlight the number you want to save, and select  > **Add to Contacts** and select whether to create a new contact or to update existing.
3. Add the contact's information and select  > **Save contact**.



Call a contact or send a message

You can call or send messages to a contact directly from the contacts list.

1. Select **Menu** >  and scroll to a contact.
2. Open the contact card, and select whether you want to call or to send a message.



Create a contact group

You can create contact groups and use them, for example, for sending a message to multiple people at the same time.

1. Select **Menu** >  >  > **Groups**.
2. Select a group, and  > **Add member**.
3. Select a contact, and press **+**. The contact is added to the group.

SEND AND RECEIVE MESSAGES

Write and send messages

1. Select **Menu** >  > **+ New message**.
2. Add the recipients. You can enter a phone number directly or add press  to add a recipient from your contacts or groups.
3. Write a message.
4. Press **Send**.

Writing options

You can find different options for writing a message from  when you are in the message field. You can insert smileys and symbols, or use ready-made templates. You can add images, sound or contact cards, discard messages, and save them as drafts.

Message options

When you have received messages in your phone, select the message without opening it, and press .

You can, for example, call the sender, delete the conversation, and add the sender to **Contacts**. You can also access **Message settings**.

5 Personalize your phone

CHANGE YOUR RING OR MESSAGE TONE

You can choose a new ringtone or message tone.

Change your ringtone

1. Select **Menu** >  > **Personalisation** > **Sounds**.
2. Select **Ringtone**.
3. Scroll to a ringtone.
4. Press **Select**.



Tip: Is your ringtone too loud or too silent? Select **Volume** and scroll left or right.

Change your message tones



1. Select **Menu** >  > **Personalisation** > **Sounds** > **Message alert**.
2. Scroll to a message tone.
3. Press **Select**.

CHANGE THE LOOK OF YOUR HOME SCREEN

Change the look of your home screen with display settings.

Choose a new wallpaper

You can change the background of your home screen with wallpapers.

1. Select **Menu** >  > **Personalisation** > **Lock screen background** > **Wallpapers**.
2. Scroll to a wallpaper and press **Select** to see how it looks on the screen.
3. Press .

You can also select a wallpaper from the photos you have on your phone.

Choose a new theme color

You can change the color that your phone uses for highlighting items such as menu options.

1. Select **Menu**  > **Personalisation** > **Theme**.
2. Scroll left or right to select a color.
3. Press **Select**.

Select a shortcut for the left and right function key

1. Select **Menu** >  > **Personalisation** > **Keypad** > **Lock screen shortcuts**.
2. Select **Right key** or **Left key** and scroll to the application or function you want.
3. Press **Select**.



6 Camera

PHOTOS

You don't need a separate camera when your phone has all you need for capturing memories.

Take a photo

Capture the best moments with your phone camera.

1. To switch the camera on, select **Menu** > .
2. To zoom in or out, scroll up or down.
3. To take a photo, select .

Before you take a photo, you can change your settings in  > **Camera settings**. You can, for example, adjust the exposure and brightness of a photo.

If you want to add effects to your photo, change the photo quality, or use the timer to better position a photo, press  and select one of the available options.



Tip: To switch the flash on, in camera, select  > **Flash** and switch it on.

View a photo you have taken



To view the photo right after taking it, select  > **Gallery**. To view the photo later, select **Menu** > **Gallery**.



Tip: To set a photo you have taken as the lock screen photo, in **Gallery**, open the photo and select  > **Set as lock screen**.

Take several photos





You can take several photos after each other with the burst mode.

1. In camera, select  > **Burst**.
2. Select how many photos you want the camera to take.
3. Go back to the viewfinder, and select . The camera takes several photos with short intervals.

To continue taking just one photo at a time, select  > **Burst** > **1**.

Edit a photo you have taken

You can edit the photos that you have taken in **Gallery**.

1. Open a photo.  scroll key to make the edits.
2. Select  > **Edit**.
3. Select what you want to edit, and use the  scroll key.
4. Select **Apply**.
5. Press .





The edited photo is saved as a new photo.

VIDEOS



You don't need a separate video camera - record video memories with your phone.

Record a video

Besides taking photos, you can also record videos with your phone.

1. To switch the video camera on, select **Menu** >  and scroll to .
2. To start recording, select .
3. To stop recording, select .

Before you start recording, you can change your settings, add effects, or switch on the video light in .

 **Tip:** Need more space for your videos? Insert a memory card, and set **Menu** >  > **Storage** > **Preferred storage** to **Memory card**.

Watch the recorded video

To view the video right after recording, select .

 **Tip:** To view the video later, select **Menu** > .

7 Internet and connections

BROWSE THE WEB

Learn how to browse the web with your phone.

Connect to internet

Catch up on the news, and visit your favorite websites on the go.

1. Select **Menu** > ●.

2. Write a web address, and press **OK**.



Tip: If you want to avoid data costs, switch mobile data off when you are not surfing the web. In your single SIM phone, select **Menu** > ⚙ > **Connectivity** > **Network settings** and switch **Mobile data** off.



Tip: If you want to avoid data costs, switch mobile data off when you are not surfing the web. In your dual SIM phone, select **Menu** > ⚙ > **Connectivity** > **Dual SIM** > **Mobile data connection**, and switch **Mobile data** off.



Tip: To open a web link from a message, scroll on top of the link and select **Go to**.

8 Music, audio and videos

MUSIC PLAYER

You can listen to your MP3 music files with the music player.

Listen to music

1. Select **Menu** > .
2. Select whether you want to view your songs, artists, albums, or playlists.
3. Scroll to a song, and select **Play**.





Tip: To listen to music using wireless headphones, pair your phone with a compatible Bluetooth headset (sold separately). To switch Bluetooth on, select **Menu** >  > **Connectivity** > **Bluetooth**, and switch **Bluetooth** to **On**.





Tip: To set a song as ringtone, select **Songs**, scroll to the song you want, and select  > **Set as ringtone**.

Create a playlist

1. Select **Menu** >  > **Songs**.
2. Scroll to a song, and select  > **Add to playlist**.
3. Scroll up and select **+ New playlist**.
4. Give the playlist a name and select **OK**.
5. Select the playlist that you just created. The song is added to that playlist.

VOICE RECORDER

Record a sound clip

1. Select **Menu** > **Voice recorder**.
2. To record, select .
3. To stop recording, select .

VIDEO PLAYER

Watch your favorite videos wherever you are.

Play a video

1. Select **Menu** > .
2. Select the video, and press **Open**.
3. Press the scroll key to pause and resume playback while watching the video.



Tip: Not all video formats are supported.

9 Radio

FIND AND SAVE RADIO STATIONS

You need to connect a compatible headset to listen to the radio. The headset acts as an antenna. Troubleshooting tip: in case the radio does not work, make sure that the headset is properly connected.

Search for radio stations

Select **Menu** > . If you open the radio for the first time, it will automatically search for the available stations and start playing. To switch to another found station, scroll left or right.

To search for all available stations later, select  > **Auto tuning**.

Save a found station as a favorite

You can save a found station into your list of favorites.

1. To save a station as a favorite, when listening to that station, select  > **Add to favourites**.
2. Select a position, and select **Add**.
3. Give the channel a name, and select **OK**.

LISTEN TO RADIO

Did you find a good radio station? Next, start listening to it!

Listen to your favorite radio stations on your phone

Select **Menu** > . The radio starts playing the last station you have listened.

To change the station, scroll left or right.

To change the volume, scroll up or down.

To close the radio, select  > **Close radio**.



Tip: To listen to a radio station using the phone's speakers, press  and switch **Speaker** on. Keep the headset connected.

10 Clock, calendar, and calculator

SET THE TIME AND DATE MANUALLY

You can set your phone clock manually.

Change the time and date

1. Select **Menu** >  > **Time & language** > **Date and time**.
2. Switch **Auto update** to **Off**.
3. Scroll down, and use the number keys to set the time and date.

ALARM CLOCK

Learn how to use the alarm clock to wake up and get to places on time.

Set an alarm

No clock around? Use your phone as an alarm clock.

1. Select **Menu** > .
2. Select **Add** to add an alarm.
3. Set the hour and minutes with the number keys.
4. Select whether the alarm repeats, and write a name for the alarm.
5. Select and alarm tone and snooze time.
6. Select **Save**.



To add another alarm, scroll up to **+ New alarm** and select **Add**.

To turn off an alarm, scroll to the alarm and select **Turn off**.

CALENDAR

Need to remember an event? Add it to your calendar.

Add a calendar reminder

1. Select **Menu** > .
2. Select a date and  > **Add new event**.
3. Type in a name for the event.
4. Scroll down, and set the date and time with

the number keys.

reminder time and a ringtone.

5. Add any other information that you want to include in the event, including a

6. Select **Save**.

CALCULATOR

Learn how to add, subtract, multiply and divide with your phone calculator.

How to calculate

1. Select **Menu** > .
2. Enter the first factor of your calculation, use the scroll key to select the operation, and enter the second factor.
3. Press the scroll key to get the result of the calculation.

Press  to empty the number fields.

11 Bluetooth

ACTIVATE BLUETOOTH

Connect your phone with Bluetooth to other devices.

Switch on Bluetooth

Select **Menu** >  > **Connectivity** > **Bluetooth** and switch **Bluetooth** on.

12 Copy, share and remove content

COPY CONTENT

Copy photos, videos, music, and other content created by you between your phone and computer.

Copy content between your phone and computer

1. Connect your phone to a compatible computer with a compatible USB cable.
2. Select **Mass storage**.
3. On your computer, open a file manager, such as Windows Explorer, and browse to your phone. You can see the content stored on your phone and on the memory card, if inserted.
4. Drag and drop items between your phone and computer.

SHARE CONTENT

Share your stuff, such as contacts, photos, videos and music easily with friends and family.

Share your content using Bluetooth

To share content with Bluetooth, make sure Bluetooth is switched on in both phones, and make sure the phones are visible to other phones.

1. To share, for example, a photo, select **Menu** > **Gallery**.
2. Open the photo that you want to share, and select **≡** > **Share**.
3. Select **Via Bluetooth**. Your phone searches for available Bluetooth devices. Press **X** once the receiving phone is found.
4. Select **Pair** and enter a passcode. The passcode can be, for example, a series of numbers that the recipient must enter on the receiving phone to confirm the connection.
5. The recipient may need to accept the files that you are sending on their phone.

Operating the device in hidden mode is a safer way to avoid malicious software. Do not accept Bluetooth connection requests from sources you do not trust. You can also switch the Bluetooth function off when you are not using it.

Share your content using multimedia messages

To share content using multimedia messages, make sure both phones are on and send and receive them.

1. To share, for example, a contact card, select **Menu** > **Contacts**.
2. Open the contact card that you want to share, and select **≡** > **Share contact**.
3. Select **Via multimedia**. Your phone opens a new message.
4. Add the recipient of the message, and select **Send**.

MEMORY

When needed, you can check how much used and how much free memory you have on your phone.

Check the amount of used and free memory

Select **Menu** > **Files** > **≡** > **Details**. The phone shows the amount of available memory, the amount of used memory, and the amount of free memory.

REMOVE PRIVATE CONTENT FROM YOUR PHONE

If you buy a new phone, or otherwise want to dispose of or recycle your phone, here's how you can remove your personal info and content.

Remove content from your phone

When removing private content from your phone, pay attention to whether you are removing content from the phone memory or the SIM card.

1. To remove messages, select **Menu** > **☰** > **≡** > **Delete conversations**. Select the conversations that you want to delete, and select **🗑️**. You can also select **≡** > **Select all** to select all conversations at one go.
2. To remove contacts, select **Menu** > **👤** > **≡** > **Delete contacts**. Select the contacts that you want to delete, and select **🗑️**. You can also select **≡** > **Select all** to select all contacts at one go.
3. To remove your call info, select **Menu** > **📞** > **≡** < **Delete all**.
4. Check that all your personal content has been removed.

13 Backup and restore

CREATE A BACKUP

Sometimes you need to create a backup of your phone data.

Create a backup

1. Select **Menu** >  > **Storage** > **Create backup** .
2. A list opens where you can select the data that you want to back up.
3. Press `<fp>icon-set.</fp>`
4. Your phone tells you that the backup will be saved to your memory card. You cannot use your phone until the backup is complete. Select **OK** to create the backup.

RESTORE A BACKUP

To restore a backup of your data you need the created backup file on a memory card.

Restore a backup

1. Select **Menu** >  > **Storage** > **Restore backup** .
2. Select the backup, and select **OK** .
3. Your phone restarts after restoring the backup files.

14 Tools

EXTRAS

Countdown timer

If you need an alarm but don't want to create one in the alarm clock, use the countdown timer. You can, for example, time something that's cooking in the kitchen.

1. Select **Menu** > **Extras** > **Countdown timer**.
2. Use the scroll keys and number keys to set the time and write a name for the timer.
3. Select **Start**.

After you have set a time in the countdown timer, return to **Menu** > **Extras**, scroll to **Countdown timer** and press the scroll key to edit or stop the timer.

Stopwatch

1. Select **Menu** > **Extras** > **Stopwatch**.
2. Select **Start**.
3. Press  when, for example, a lap has been completed.

To stop, select **Stop** and press .

Converter

1. Select **Menu** > **Extras** > **Converter**.
2. Select what you want to convert and how do you want to convert it.
3. Use the number keys to write both measurements. Converter converts the measurements automatically.

TORCH

Use the flashlight

Select **Menu** > **Torch**. Press the scroll key once to switch the flashlight on, and press again to switch the flashlight off.

Do not shine the light in anyone's eyes.

COUNTERS

Check and clear counters

Counters keep track of the amount of mobile data used, the calls made and messages sent using your SIM card. If you have a dual SIM phone, both SIM cards are tracked separately.

To check the details of your SIM card usage, select **Menu** > **Counters**. Select the SIM card and press the scroll key.

To clear all counters, select **≡** > **Clear all counters**.

15 Settings

SYSTEM SETTINGS

Available system settings

Select **Menu** >  > **System**.

In system settings, you can edit, for example:

- **Call settings**, including call forwarding, voicemail number, and cost settings
- Settings for **Messages**, including whether to send delivery reports for messages and whether to receive multimedia messages when roaming
- **Backlight** settings, including the brightness and timeout of your keypad backlight
- Settings for **Notifications**, including what notifications to see in your standby mode

Reset your phone

Accidents may happen and your phone may stop responding. You can restore the original factory settings, but be careful, since this reset removes all data you have saved in the phone memory and all your personalization.

If you are disposing your phone, note that you are responsible of removing all private content.

You may need to have the security code to restore the original settings. To reset your phone to its original settings and to remove all your data, on the home screen, type in *#7370#.

1. Select **Menu** >  > **System** > **About** > **Restore factory settings**.
2. There is no more confirmation after you select **OK**, but the phone is reset and all data is removed.
3. The phone reboots.

Send feedback

You can send feedback on your phone directly from **Settings**.

1. Select **Menu** >  > **System** > **About** > **Send feedback**.
2. Give feedback to questions as instructed, and select **Send**.

CONNECTIVITY SETTINGS

Available connectivity settings

Select **Menu** >  > **Connectivity**.

In connectivity settings, you can edit, for example:

- **Bluetooth** settings, including the phone name and visibility
- **Dual SIM** settings, including the preferred SIM or calls and messages
- **Access point** settings, which change the way you connect to the internet
- Settings for **Network type**, which change the preferred network

Flight mode

When you are flying or in other locations where phone use is restricted, use the flight mode.

To activate flight mode, select **Menu** >  > **Connectivity** and switch **Flight mode** on.

Flight mode closes connections to the cellular network and switches your device's wireless features off. Comply with the instructions and safety requirements given by, for example, an airline, and any applicable laws and regulations.

Restrict mobile data usage with data roaming

If you want to avoid extra costs, you can change the data roaming settings.

Select **Menu** >  > **Connectivity** and switch **Data roaming** off.

PERSONALIZATION SETTINGS

Change your ringtone



1. Select **Menu** >  > **Personalisation** > **Sounds**.
2. Select **Ringtone**.
3. Scroll to a ringtone.
4. Press **Select**.

Change your message tones

1. Select **Menu** >  > **Personalisation** > **Sounds** > **Message alert**.
2. Scroll to a message tone.
3. Press **Select**.

Choose a new wallpaper

You can change the background of your home screen with wallpapers.

1. Select **Menu** >  > **Personalisation** > **Lock screen background** > **Wallpapers**.
2. Scroll to a wallpaper and press **Select** to see how it looks on the screen.
3. Press .

You can also select a wallpaper from the photos you have on your phone.

Choose a new theme color

You can change the color that your phone uses for highlighting items such as menu options.

1. Select **Menu**  > **Personalisation** > **Theme**.
2. Scroll left or right to select a color.
3. Press **Select**.

Select a shortcut for the left and right function key

1. Select **Menu** >  > **Personalisation** > **Keypad** > **Lock screen shortcuts**.
2. Select **Right key** or **Left key** and scroll to the application or function you want.
3. Press **Select**.

TIME AND LANGUAGE SETTINGS

Change the time and date

1. Select **Menu** >  > **Time & language** > **Date and time**.
2. Switch **Auto update** to **Off**.
3. Scroll down, and use the number keys to set the time and date.

SECURITY SETTINGS

You can edit the available security settings.

Lock the keypad

To lock the keys automatically, select **Menu** >  > **Security** > **Keyguard** > **Automatic keyguard** and select **On**.

Use a security code

You can set the phone to ask for a security code. If there is a pre-set code, it is 12345. Change it to protect your privacy and personal data. Note, however, that when you change the code, you need to remember the new code, as HMD Global is not able to open or bypass it. This phone cannot be located or locked remotely if lost.

1. Select **Menu** >  > **Security** > **Keyguard** and switch **Security code** on.
2. Enter the security code and select **OK**.

16 Product and safety information

FOR YOUR SAFETY

Read these simple guidelines. Not following them may be dangerous or against local laws and regulations. For further info, read the complete user guide.

SWITCH OFF IN RESTRICTED AREAS



Switch the device off when mobile device use is not allowed or when it may cause interference or danger, for example, in aircraft, in hospitals or near medical equipment, fuel, chemicals, or blasting areas. Obey all instructions in restricted areas.

ROAD SAFETY COMES FIRST



Obey all local laws. Always keep your hands free to operate the vehicle while driving. Your first consideration while driving should be road safety.

INTERFERENCE



All wireless devices may be susceptible to interference, which could affect performance.

AUTHORIZED SERVICE



Only authorized personnel may install or repair this product.

BATTERIES, CHARGERS, AND OTHER ACCESSORIES



Use only batteries, chargers, and other accessories approved by HMD Global Oy for use with this device. Do not connect incompatible products.

KEEP YOUR DEVICE DRY



If your device is water-resistant, see its IP rating in the device's technical specifications for more detailed guidance.

PROTECT YOUR HEARING



To prevent possible hearing damage, do not listen at high volume levels for long periods. Exercise caution when holding your device near your ear while the loudspeaker is in use.

SAR



This device meets RF exposure guidelines when used either in the normal use position against the ear or when positioned at least 1.5 centimetres (5/8 inch) away from the body. The specific maximum SAR values can be found in the Certification Information (SAR) section of this user guide. For more information, see the Certification Information (SAR) section of this user guide or go to www.sar-tick.com.

NETWORK SERVICES AND COSTS

Using some features and services, or downloading content, including free items, require a network connection. This may cause the transfer of large amounts of data, which may result in data costs. You may also need to subscribe to some features.

You can only use your device on the GSM 900/1800 and WCDMA1 and 8 networks. You need a subscription with a service provider.

EMERGENCY CALLS

 **Important:** Connections in all conditions cannot be guaranteed. Never rely solely on any wireless phone for essential communications like medical emergencies.

Before making the call:

- Switch the phone on.
 - If the phone screen and keys are locked, unlock them.
 - Move to a place with adequate signal strength.
1. Press the end key repeatedly, until the home screen is shown.
 2. Type in the official emergency number for your present location. Emergency call numbers vary by location.
 3. Press the call key.
 4. Give the necessary info as accurately as possible. Do not end the call until given permission to do so.

You may also need to do the following:

- Put a SIM card in the phone.
- If your phone asks for a PIN code, type in the official emergency number for your present location, and press the call key.
- Switch the call restrictions off in your phone, such as call barring, fixed dialling, or closed user group.

TAKE CARE OF YOUR DEVICE

Handle your device, battery, charger and accessories with care. The following suggestions help you keep your device operational.

- Keep the device dry. Precipitation, humidity, and all types of liquids or moisture can contain minerals that corrode electronic circuits.
- Do not use or store the device in dusty or dirty areas.
- Do not store the device in high temperatures. High temperatures may damage the device or battery.
- Do not store the device in cold temperatures. When the device warms to its normal temperature, moisture can form inside the device and damage it.
- Do not open the device other than as instructed in the user guide.
- Unauthorized modifications may damage the device and violate regulations governing radio devices.
- Do not drop, knock, or shake the device or the battery. Rough handling can break it.
- Only use a soft, clean, dry cloth to clean the surface of the device.
- Do not paint the device. Paint can prevent proper operation.
- Keep the device away from magnets or magnetic fields.
- To keep your important data safe, store it in at least two separate places, such as your device, memory card, or computer, or write down important info.

During extended operation, the device may feel warm. In most cases, this is normal. To avoid getting too warm, the device may automatically slow down, close apps, switch off charging, and if necessary, switch itself off. If the device is not working properly, take it to the nearest authorized service facility.

RECYCLE



Always return your used electronic products, batteries, and packaging materials to dedicated collection points. This way you help prevent uncontrolled waste disposal and promote the recycling of materials. Electrical and electronic products contain a lot of valuable materials, including metals (such as copper, aluminum, steel, and magnesium) and precious metals (such as gold, silver, and palladium). All materials of the device can be recovered as materials and energy.

CROSSED-OUT WHEELIE BIN SYMBOL

Crossed-out wheelie bin symbol



The crossed-out wheelie-bin symbol on your product, battery, literature, or packaging reminds you that all electrical and electronic products and batteries must be taken to separate collection at the end of their working life. Remember to remove personal data from the device first. Do not dispose of these products as unsorted municipal waste: take them for recycling. For info on your nearest recycling point, check with your local waste authority, or read about HMD's take-back program and its availability in your country at www.hmd.com/phones/support/topics/recycle.

BATTERY AND CHARGER INFORMATION

Battery and charger

Use your device only with an original BL-4UL rechargeable battery.

Charge your device with AC-18 charger. Charger plug type may vary.

HMD Global may make additional battery or charger models available for this device.

Battery type: BL-4UL

Battery and charger safety info

To unplug a charger or an accessory, hold and pull the plug, not the cord.

When your charger is not in use, unplug it. If left unused, a fully charged battery will lose its charge over time.

Always keep the battery between 59°F and 77°F (15°C and 25°C) for optimal performance. Extreme temperatures reduce the capacity and lifetime of the battery. A device with a hot or cold battery may not work temporarily. Accidental short-circuiting can happen when a metallic object touches the metal strips on the battery. This may damage the battery or the other object.

Do not dispose of batteries in a fire as they may explode. Obey local regulations. Recycle when possible. Do not dispose as household waste.

Do not dismantle, cut, crush, bend, puncture, or otherwise damage the battery in any way. If a battery leaks, do not let liquid touch skin or eyes. If this happens, immediately flush the affected areas with water, or seek medical help. Do not modify, attempt to insert foreign objects into the battery, or immerse or expose it to water or other liquids. Batteries may explode if damaged.

Use the battery and charger for their intended purposes only. Improper use, or use of unapproved or incompatible batteries or chargers may present a risk of fire, explosion, or other hazard, and may invalidate any approval or warranty. If you believe the battery or charger is damaged, take it to a service centre or your phone dealer before continuing to use it. Never use a damaged battery or charger. Only use the charger indoors. Do not charge your device during a lightning storm.

SMALL CHILDREN

Your device and its accessories are not toys. They may contain small parts. Keep them out of the reach of small children.

MEDICAL DEVICES

Operation of radio transmitting equipment, including wireless phones, may interfere with inadequately shielded medical devices' function. Consult a physician or the medical device's manufacturer to determine if it is adequately shielded from external radio energy.

IMPLANTED MEDICAL DEVICES

To avoid potential interference, manufacturers of implanted medical devices (such as cardiac pacemakers, insulin pumps, and neurostimulators) recommend a minimum separation of 15.3 centimeters (6 inches) between a wireless device and the medical device. Persons who have such devices should:

- Always keep the wireless device more than 15.3 centimeters (6 inches) from the medical device.
- Not carry the wireless device in a breast pocket.
- Hold the wireless device to the ear opposite the medical device.
- Switch the wireless device off if there is any reason to suspect that interference is taking place.
- Follow the manufacturer directions for the implanted medical device.

If you have any questions about using your wireless device with an implanted medical device, consult your health care provider.

HEARING



Warning: When you use the headset, your ability to hear outside sounds may be affected. Do not use the headset where it can endanger your safety.

Some wireless devices may interfere with some hearing aids.

PROTECT YOUR DEVICE FROM HARMFUL CONTENT

Your device may be exposed to viruses and other harmful content. Take the following precautions:

- Be cautious when opening messages. They may contain malicious software or otherwise be harmful to your device or computer.
- Be cautious when accepting connectivity requests, browsing the internet, or downloading content. Do not accept Bluetooth connections from sources you do not trust.
- Only install and use services and software from sources that you trust and that offer adequate security and protection.
- Install antivirus and other security

software on your device and any connected computer. Only use one antivirus app at a time. Using more may affect performance and operation of the device and/or computer.

- If you access preinstalled bookmarks and links to third party internet sites, take the appropriate precautions. HMD Global does not endorse or assume liability for such sites.

VEHICLES

Radio signals may affect improperly installed or inadequately shielded electronic systems in vehicles. For more info, check with the manufacturer of your vehicle or its equipment. Only authorized personnel should install the device in a vehicle. Faulty installation may be dangerous and invalidate your warranty. Check regularly that all wireless device equipment in your vehicle is mounted and operating properly. Do not store or carry flammable or explosive materials in the same compartment as the device, its parts, or accessories. Do not place your device or accessories in the air bag deployment area.

POTENTIALLY EXPLOSIVE ENVIRONMENTS

Switch your device off in potentially explosive environments, such as near gasoline pumps. Sparks may cause an explosion or fire resulting in injury or death. Note restrictions in areas with fuel; chemical plants; or where blasting operations are in progress. Areas with a potentially explosive environment may not be clearly marked. These usually are areas where you are advised to switch your engine off, below deck on boats, chemical transfer or storage facilities, and where the air contains chemicals or particles. Check with the manufacturers of vehicles using liquefied petroleum gas (such as propane or butane) if this device can be safely used in their vicinity.

CERTIFICATION INFORMATION

This mobile device meets guidelines for exposure to radio waves.

Your mobile device is a radio transmitter and receiver. It is designed not to exceed the limits for exposure to radio waves (radio frequency electromagnetic fields), recommended by international guidelines from the independent scientific organization ICNIRP. These guidelines incorporate substantial safety margins that are intended to assure the protection of all persons regardless of age and health. The exposure guidelines are based on the Specific Absorption Rate (SAR), which is an expression of the amount of radio frequency (RF) power deposited in the head or body when the device is transmitting. The ICNIRP SAR limit for mobile devices is 2.0 W/kg averaged over 10 grams of tissue.

SAR tests are carried out with the device in standard operating positions, transmitting at its highest certified power level, in all its frequency bands.

This device meets RF exposure guidelines when used against the head or when positioned at least 5/8 inch (1.5 centimetres) away from the body. When a carry case, belt clip or other

form of device holder is used for body-worn operation, it should not contain metal and should provide at least the above stated separation distance from the body.

To send data or messages, a good connection to the network is needed. Sending may be delayed until such a connection is available. Follow the separation distance instructions until the sending is finished.

During general use, the SAR values are usually well below the values stated above. This is because, for purposes of system efficiency and to minimize interference on the network, the operating power of your mobile device is automatically decreased when full power is not needed for the call. The lower the power output, the lower the SAR value.

Device models may have different versions and more than one value. Component and design changes may occur over time and some changes could affect SAR values.

For more info, go to www.sar-tick.com. Note that mobile devices may be transmitting even if you are not making a voice call.

The World Health Organization (WHO) has stated that current scientific information does not indicate the need for any special precautions when using mobile devices. If you are interested in reducing your exposure, they recommend you limit your usage or use a hands-free kit to keep the device away from your head and body. For more information and explanations and discussions on RF exposure, go to the WHO website at www.who.int/health-topics/electromagnetic-fields#tab=tab_1.

Please refer to www.hmd.com/sar for the maximum SAR value of the device.

COPYRIGHTS AND OTHER NOTICES

Declaration of Conformity

Hereby, HMD Global Oy (Ltd.) declares that this product is in compliance with the essential requirements and other relevant provisions of Directive 2014/53/EC. A copy of the Declaration of Conformity can be found at www.hmd.com/declaration-of-conformity.

The availability of products, features, apps and services may vary by region. For more info, contact your dealer or your service provider.

This device may contain commodities, technology or software subject to export laws and regulations from the US and other countries. Diversion contrary to law is prohibited.

The contents of this document are provided "as is". Except as required by applicable law, no warranties of any kind, either express or implied, including, but not limited to, the implied warranties of merchantability and fitness for a particular purpose, are made in relation to the accuracy, reliability or contents of this document. HMD Global reserves the right to revise this document or withdraw it at any time without prior notice.

To the maximum extent permitted by applicable law, under no circumstances shall HMD Global or any of its licensors be responsible for any loss of data or income or any special, incidental, consequential or indirect damages howsoever caused.

Reproduction, transfer or distribution of part or all of the contents in this document in any form without the prior written permission of HMD Global is prohibited. HMD Global operates a policy of continuous development. HMD Global reserves the right to make changes and improvements to any of the products described in this document without prior notice.

HMD Global does not make any representations, provide a warranty, or take any responsibility for the functionality, content, or end-user support of third-party apps provided with your device. By using an app, you acknowledge that the app is provided as is.

Downloading of maps, games, music and videos and uploading of images and videos may involve transferring large amounts of data. Your service provider may charge for the data transmission. The availability of particular products, services and features may vary by region. Please check with your local dealer for further details and availability of language options.

Certain features, functionality and product specifications may be network dependent and subject to additional terms, conditions, and charges. All are subject to change without notice.

Manufacturer and/or importer in EU: HMD Global Oy, Bertel Jungin aukio 9, 02600 Espoo, Finland.

HMD Global Privacy Policy, available at www.hmd.com/privacy, applies to your use of the device.

© 2017 HMD Global. All rights reserved. HMD Global Oy is the exclusive licensee of the Nokia brand for phones & tablets. Nokia is a registered trademark of Nokia Corporation.

The Bluetooth word mark and logos are owned by the Bluetooth SIG, Inc. and any use of such marks by HMD Global is under license.

This product includes open source software. For applicable copyright and other notices, permissions, and acknowledgements, select `*#6774#` on the home screen.

ABOUT DIGITAL RIGHTS MANAGEMENT

When using this device, obey all laws and respect local customs, privacy and legitimate rights of others, including copyrights. Copyright protection may prevent you from copying, modifying, or transferring photos, music, and other content.