

NOKIA

Nokia 150 (2020)

User Guide

Table of Contents

1	About this user guide	4
2	Get started	5
	Keys and parts	5
	Set up and switch on your phone	6
	Charge your phone	8
	Keypad	9
	Write text	9
3	Calls, contacts, and messages	10
	Calls	10
	Contacts	10
	Send messages	11
4	Personalize your phone	12
	Change tones	12
	Change the look of your home screen	12
	Profiles	12
	Add shortcuts	13
5	Camera	14
	Photos and videos	14
6	Bluetooth	15
	Bluetooth® connections	15
7	Music	16
	Music player	16
	Listen to radio	16

8	Clock, calendar, and calculator	17
	Set the time and date manually	17
	Alarm clock	17
	Calendar	17
	Calculator	17
9	Empty your phone	19
	Restore factory settings	19
10	Product and safety information	20
	For your safety	20
	Emergency calls	22
	Take care of your device	23
	Recycle	24
	Crossed-out wheelie bin symbol	24
	Battery and charger information	24
	Small children	25
	Medical devices	25
	Implanted medical devices	25
	Hearing	26
	Protect your device from harmful content	26
	Vehicles	26
	Potentially explosive environments	27
	Certification information	27
	About Digital Rights Management	28
	Copyrights and other notices	28

1 About this user guide



Important: For important information on the safe use of your device and battery, read “Product and safety information” before you take the device into use. To find out how to get started with your new device, read the user guide.

2 Get started

KEYS AND PARTS

Your phone

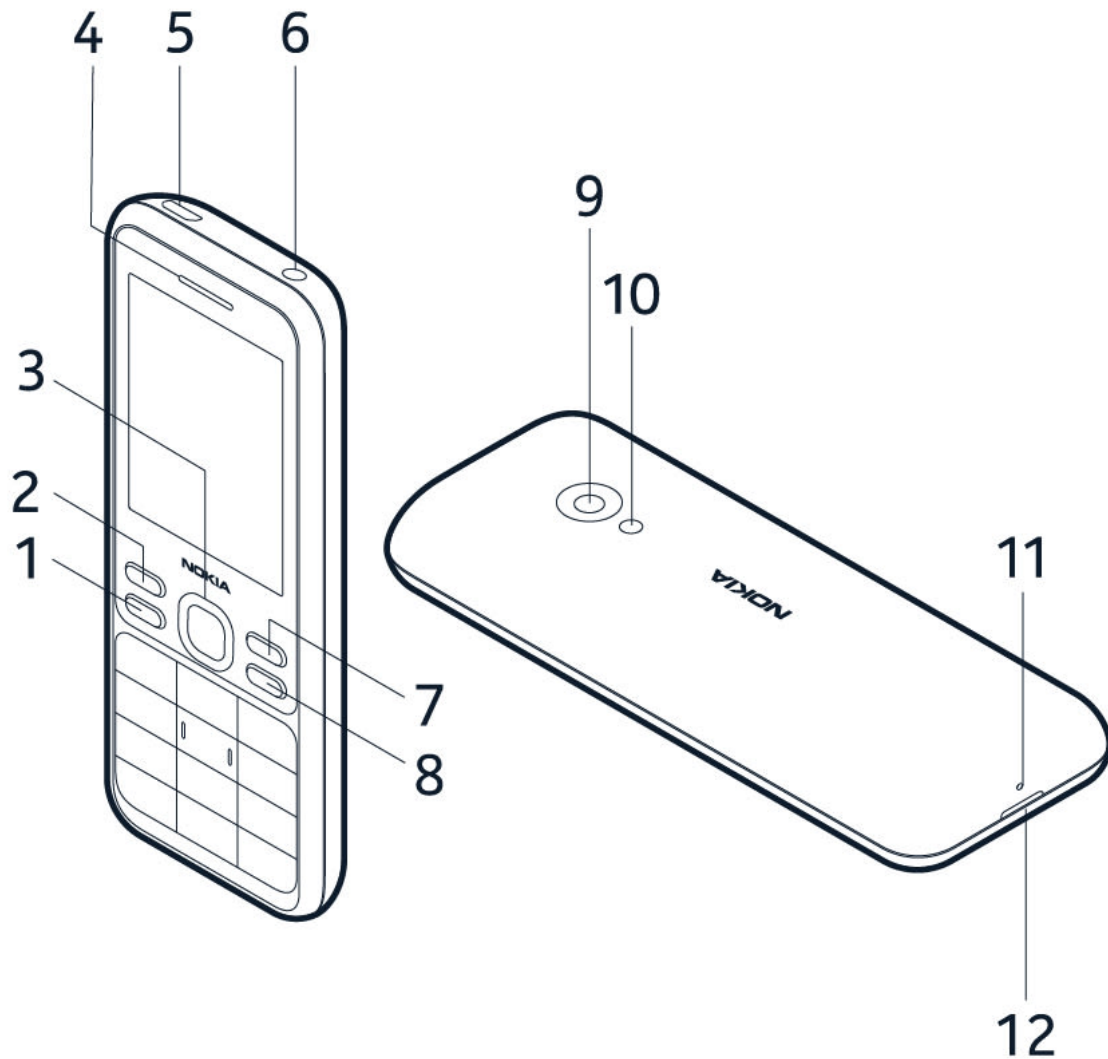

This user guide applies to the following model: TA-1235.

- | | |
|-------------------------|-----------------------------|
| 1. Call key | 7. Right selection key |
| 2. Left selection key | 8. Power/End key |
| 3. Scroll key | 9. Camera |
| 4. Earpiece/Loudspeaker | 10. Flash |
| 5. USB connector | 11. Microphone |
| 6. Headset connector | 12. Back cover opening slot |

Avoid touching the antenna area while the antenna is in use. Contact with antennas affects the communication quality and may reduce battery life due to higher power level during operation.

Do not connect to products that create an output signal, as this may damage the device. Do not connect any voltage source to the audio connector. If you connect an external device or headset, other than those approved for use with this device, to the audio connector, pay special attention to volume levels. Parts of the device are magnetic. Metallic materials may be attracted to the device. Do not place credit cards or other magnetic storage media near the device, because info stored on them may be erased.

Some of the accessories mentioned in this user guide, such as charger, headset, or data cable, may be sold separately.

 **Note:** The pre-set security code is 12345. To switch on the security code, select **Menu** > **Settings** > **Security settings** > **Phone security**, enter the code 12345 and select **OK**, and then select **On**. To change the security code, select **Menu** > **Settings** > **Security settings** > **Change access codes** > **Change security code**, enter the current security code and select **OK**. Enter your new code and select **OK**, then enter the new code again and select **OK**. When you change the code, you need to remember the new code, as HMD Global is not able to open or bypass it.

SET UP AND SWITCH ON YOUR PHONE

Mini SIM



Important: This device is designed to be used with a mini SIM card only. Use of incompatible SIM cards may damage the card or the device, and may corrupt data stored on the card.

 **Note:** Switch the device off and disconnect the charger and any other device before removing any covers. Avoid touching electronic components while changing any covers. Always store and use the device with any covers attached.

Insert the SIM card

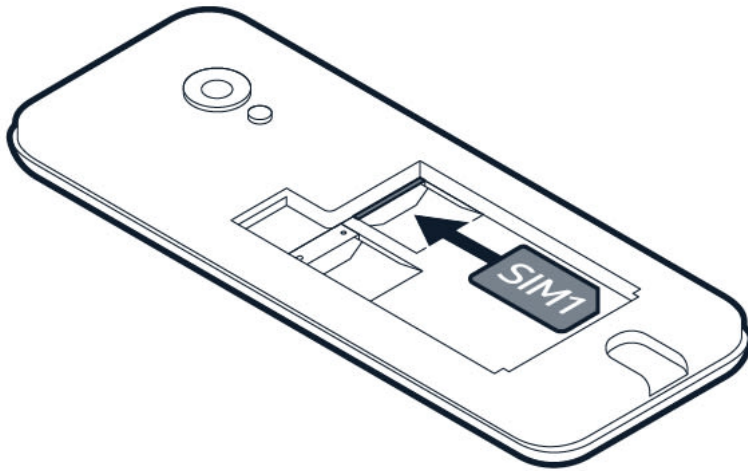

1. Put your fingernail in the small slot at the bottom of the phone, lift and remove the cover.
2. If the battery is in the phone, lift it out.
3. Slide the SIM card in the SIM card slot.

Insert the second SIM

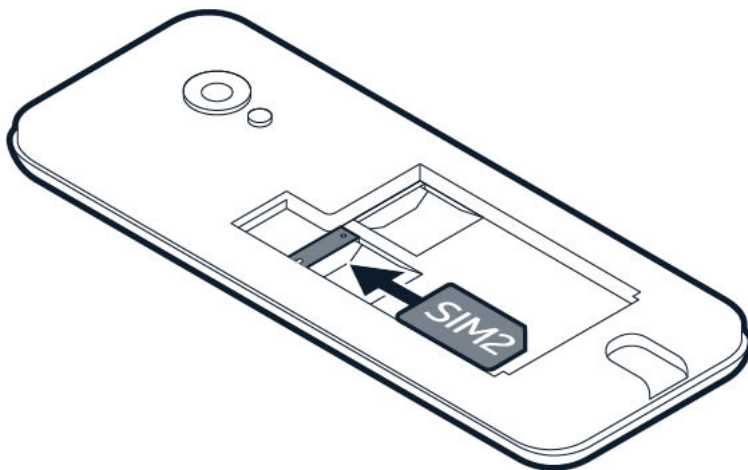

If you have a second SIM, slide it in the SIM2 slot. Both SIM cards are available at the same time when the device is not being used, but while one SIM card is active, for example, making a call, the other may be unavailable.

Insert the memory card

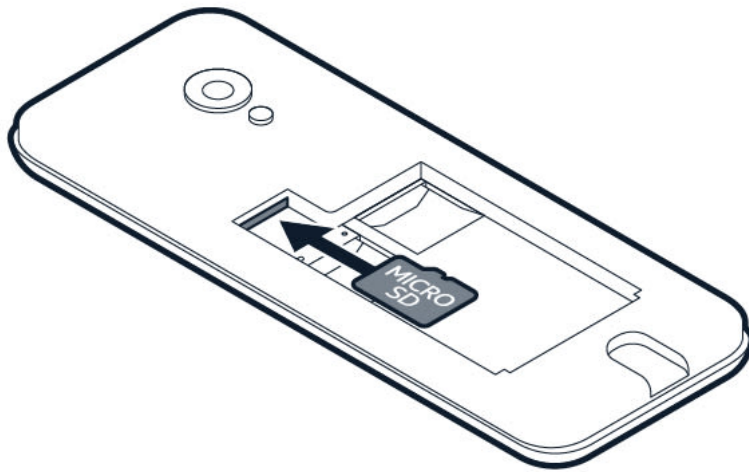

1. If you have a memory card, slide it in the memory card slot.
2. Put back the battery.
3. Put back the cover.

Switch on your phone

Press and hold the power key.

CHARGE YOUR PHONE

Your battery has been partially charged at the factory, but you may need to recharge it before you can use your phone.

Charge the battery

1. Plug the charger into a wall outlet.
2. Connect the charger to the phone. When done, unplug the charger from the phone, then from the wall outlet.

If the battery is completely discharged, it may take several minutes before the charging indicator is displayed.



Tip: You can use USB charging when a wall outlet is not available. Data can be transferred while charging the device. The efficiency of USB charging power varies significantly, and it may take a long time for charging to start and the device to start functioning. Make sure your computer is switched on.

KEYPAD

Use the phone keys

- To see the apps and features of your phone, on the home screen, select **Menu**.
- To go to an app or feature, press the scroll key up, down, left, or right. To open the app or feature, press the scroll key.
- To go back to the home screen, press the end key.
- To change the volume of your phone, scroll up or down.
- To switch on the flashlight, on the home screen, press the scroll key up twice. To switch it off, scroll up once. Do not shine the light in anyone's eyes.

Lock the keypad

To avoid accidentally pressing the keys, lock the keypad: select **Go to** > **Lock keypad**. To unlock the keypad, press the end key and select **Unlock**.

WRITE TEXT

Write using the keypad

Press a key repeatedly until the letter is shown.

To type in a space press the 0 key.

To type in a special character or punctuation mark, press the asterisk key, or if you are using predictive text, press and hold the asterisk key.

To switch between character cases, press the # key repeatedly.

To type in a number, press and hold a number key.

3 Calls, contacts, and messages

CALLS

Make a call

1. Type in the phone number. To type in the + character, used for international calls, press * twice.
2. Press the call key. If asked, select which SIM to use.
3. To end the call, press the end key.

Answer a call

Press the call key.



Tip: If you are in a situation where you cannot answer the phone and you need to silence it quickly, select **Silence**.

CONTACTS

Add a contact

1. Select **Menu** >  > **Add contact**.
2. Select where to save the contact.
3. Write the name, and type in the number.
4. Select **OK**.

Save a contact from call log

1. Select **Menu** >  > **Missed calls**, **Received calls**, or **Dialled numbers**, depending on from where you want to save the contact.
2. Scroll to the number you want to save, select **Opt.** > **Save**, and select where you want to save the contact.
3. Add the contact's name, check that the phone number is correct, and select **OK**.

Call a contact

You can call a contact directly from the contacts list.

1. Select **Menu** > .
2. Select **Names** and scroll to the contact you want to call.
3. Press the call key.

SEND MESSAGES

Write and send messages

1. Select **Menu** >  > **Create message**.
2. Write your message.
3. Press the call key. If asked, select which SIM to use.
4. Type in a phone number, or select a recipient from your contacts list or groups, and select **OK**.

4 Personalize your phone

CHANGE TONES

Set new tones

1. Select **Menu** >  > **Tone settings**.
2. Select which tone you want to change and select for which SIM card you want to change it, if asked.
3. Scroll to the tone that you want and select **OK**.

CHANGE THE LOOK OF YOUR HOME SCREEN

Choose a new wallpaper

You can change the background of your home screen.

1. Select **Menu** >  > **Display settings** > **Wallpaper**.
2. Select **Default**, scroll to the wallpaper you want, and select **View**.
3. If you like the wallpaper, select **Select** and then select how you want to position the wallpaper on the home screen.



Tip: You can also use a photo you've taken or received as wallpaper. Select **Menu** >  > **Display settings** > **Wallpaper** > **Photos**.

Show date and time

You can select to see date and time on the home screen of your phone.

Select **Menu** >  > **Time settings** > **Display of time and date** > **Show clock**.

If you want your phone to update the time automatically, set **Auto-update of date and time** on. You may need to restart your phone for this setting to work.



Tip: You can also set your phone to show the time even in the idle mode. Select **Menu** >  > **Display settings** > **Standby screen** > **On**.

PROFILES

Your phone has different profiles for different situations. You can edit the profiles to your liking.

Personalize profiles

There are several profiles that you can use in different situations. There is, for example, a silent profile for when you cannot have sounds on, and an outdoor profile with loud tones.

You can personalize profiles further.

1. Select **Menu** > **⚙️** > **Profiles**.
2. Select a profile and **Personalise**.

For each profile you can set a specific ringtone, ringtone volume, message sounds and so on.

ADD SHORTCUTS

You can add shortcuts to different apps and settings on your home screen.

Edit Go to settings

On the bottom left of your home screen is **Go to**, which contains shortcuts to various apps and settings. Select the shortcuts that are the handiest for you.

1. Select **Menu** > **⚙️** > **Go to settings**.
2. Select **Select options**.
3. Scroll to each shortcut you want to have on the **Go to** list and select **Mark**.
4. Select **Done** > **Yes** to save the changes.

You can also reorganize your **Go to** list.

1. Select **Organise**.
2. Scroll to the item you want to move, select **Move** and where you want to move it.
3. Select **Back** > **Yes** to save the changes.

5 Camera



PHOTOS AND VIDEOS

To use the camera, you need to insert a memory card in the phone.

Take a photo

1. Select **Menu** > .
2. To zoom in or out, scroll up or down.
3. To take a photo, select **Capture**.

Record a video

1. Select **Menu** > .
2. Scroll right and select .
3. To stop the video, select .

6 Bluetooth

BLUETOOTH® CONNECTIONS

Switch on Bluetooth

Before transferring files using Bluetooth, insert a memory card in your phone.

1. Select **Menu** > .
2. Switch **Bluetooth** to **On**.
3. Select **Paired devices** to find a new device or a device you have paired your phone with previously, or select **Active devices** to see a list of devices available for connecting.

7 Music

MUSIC PLAYER

You can listen to your MP3 music files with the music player. To play music, you need to store the music files on a memory card.

Listen to music

1. Select **Menu** > .
2. Select **Opt.** > **All songs** to see all your saved music.
3. Scroll to a song, and select **Play**.

To adjust the volume, scroll up or down.



Tip: To set a song as ringtone, select **Opt.** > **Use as ringtone**.

LISTEN TO RADIO

Listen to your favorite radio stations

1. Select **Menu** > .
2. To search for all available stations select **OK**.

To change the volume, scroll up or down. To move between available stations, scroll left or right. To save a station, select **Opt.** > **Save channel**, give the station a name, and select a location for it. To switch to a saved station, press the corresponding number key on the phone's keypad. To close the radio, select **Stop**.

8 Clock, calendar, and calculator

SET THE TIME AND DATE MANUALLY

Change the time and date

1. Select **Menu** >  > **Time settings**.
2. Switch **Auto-update of date and time** to **Off**.
3. To set the time, select **Clock** > **Set the time**. Use the scroll key to set the time, and select **OK**.
4. To set the date, select **Date setting**. Use the scroll key to set the date, and select **OK**.

ALARM CLOCK

Set an alarm

1. Select **Menu** > .
2. Select an alarm and use the scroll key to set the time.
3. Select **OK**.

If you want the alarm to repeat on certain days, select the alarm, then select **Repeat alarm** > **Repeat alarm**, scroll to each day you want the alarm to sound on, and select **Mark**. Then select **Done** > **Yes**.

CALENDAR

Add a calendar event

1. Select **Menu** > .
2. Scroll to a date, and select **Opt.** > **Add reminder**.
3. Enter the event name, and select **OK**.
4. Select whether to add an alarm to the event, and select **OK**.

CALCULATOR

Learn how to add, subtract, multiply and divide with your phone calculator.

How to calculate

1. Select **Menu** > .
2. Enter the first factor of your calculation, use the scroll key to select the operation, and enter the second factor.
3. Select **Equals** to get the result of the calculation.

Select **Clear** to empty the number fields.

9 Empty your phone

RESTORE FACTORY SETTINGS

Reset your phone

You can restore the original factory settings, but be careful, since this reset removes all data you have saved in the phone memory and all your personalization.

If you are disposing your phone, note that you are responsible of removing all private content.

To reset your phone to its original settings and to remove all your data, on the home screen, type in `*#7370#`. If asked, enter your security code.

10 Product and safety information

FOR YOUR SAFETY

Read these simple guidelines. Not following them may be dangerous or against local laws and regulations. For further info, read the complete user guide.

SWITCH OFF IN RESTRICTED AREAS



Switch the device off when mobile device use is not allowed or when it may cause interference or danger, for example, in aircraft, in hospitals or near medical equipment, fuel, chemicals, or blasting areas. Obey all instructions in restricted areas.

ROAD SAFETY COMES FIRST



Obey all local laws. Always keep your hands free to operate the vehicle while driving. Your first consideration while driving should be road safety.

INTERFERENCE



All wireless devices may be susceptible to interference, which could affect performance.

AUTHORIZED SERVICE



Only authorized personnel may install or repair this product.

BATTERIES, CHARGERS, AND OTHER ACCESSORIES



Use only batteries, chargers, and other accessories approved by HMD Global Oy for use with this device. Do not connect incompatible products.

KEEP YOUR DEVICE DRY



If your device is water-resistant, see its IP rating in the device's technical specifications for more detailed guidance.

PROTECT YOUR HEARING



To prevent possible hearing damage, do not listen at high volume levels for long periods. Exercise caution when holding your device near your ear while the loudspeaker is in use.

SAR



This device meets RF exposure guidelines when used either in the normal use position against the ear or when positioned at least 1.5 centimetres (5/8 inch) away from the body. The specific maximum SAR values can be found in the Certification Information (SAR) section of this user guide. For more information, see the Certification Information (SAR) section of this user guide or go to www.sar-tick.com.

EMERGENCY CALLS

 **Important:** Connections in all conditions cannot be guaranteed. Never rely solely on any wireless phone for essential communications like medical emergencies.

Before making the call:

- Switch the phone on.
- If the phone screen and keys are locked, unlock them.
- Move to a place with adequate signal strength.

1. Press the end key repeatedly, until the home screen is shown.

2. Type in the official emergency number for your present location. Emergency call numbers vary by location.
3. Press the call key.
4. Give the necessary info as accurately as possible. Do not end the call until given permission to do so.

You may also need to do the following:

- Put a SIM card in the phone.
- If your phone asks for a PIN code, type in the official emergency number for your present location, and press the call key.
- Switch the call restrictions off in your phone, such as call barring, fixed dialling, or closed user group.

TAKE CARE OF YOUR DEVICE

Handle your device, battery, charger and accessories with care. The following suggestions help you keep your device operational.

- Keep the device dry. Precipitation, humidity, and all types of liquids or moisture can contain minerals that corrode electronic circuits.
- Do not use or store the device in dusty or dirty areas.
- Do not store the device in high temperatures. High temperatures may damage the device or battery.
- Do not store the device in cold temperatures. When the device warms to its normal temperature, moisture can form inside the device and damage it.
- Do not open the device other than as instructed in the user guide.
- Unauthorized modifications may damage the device and violate regulations governing radio devices.
- Do not drop, knock, or shake the device or the battery. Rough handling can break it.
- Only use a soft, clean, dry cloth to clean the surface of the device.
- Do not paint the device. Paint can prevent proper operation.
- Keep the device away from magnets or magnetic fields.
- To keep your important data safe, store it in at least two separate places, such as your device, memory card, or computer, or write down important info.

During extended operation, the device may feel warm. In most cases, this is normal. To avoid getting too warm, the device may automatically slow down, close apps, switch off charging, and if necessary, switch itself off. If the device is not working properly, take it to the nearest authorized service facility.

RECYCLE



Always return your used electronic products, batteries, and packaging materials to dedicated collection points. This way you help prevent uncontrolled waste disposal and promote the recycling of materials. Electrical and electronic products contain a lot of valuable materials, including metals (such as copper, aluminum, steel, and magnesium) and precious metals (such as gold, silver, and palladium). All materials of the device can be recovered as materials and energy.

CROSSED-OUT WHEELIE BIN SYMBOL

Crossed-out wheelie bin symbol



The crossed-out wheelie-bin symbol on your product, battery, literature, or packaging reminds you that all electrical and electronic products and batteries must be taken to separate collection at the end of their working life. Remember to remove personal data from the device first. Do not dispose of these products as unsorted municipal waste: take them for recycling. For info on your nearest recycling point, check with your local waste authority, or read about HMD's take-back program and its availability in your country at www.hmd.com/phones/support/topics/recycle.

BATTERY AND CHARGER INFORMATION

Battery and charger safety info

To unplug a charger or an accessory, hold and pull the plug, not the cord.

When your charger is not in use, unplug it. If left unused, a fully charged battery will lose its charge over time.

Always keep the battery between 59°F and 77°F (15°C and 25°C) for optimal performance. Extreme temperatures reduce the capacity and lifetime of the battery. A device with a hot or cold battery may not work temporarily. Accidental short-circuiting can happen when a metallic object touches the metal strips on the battery. This may damage the battery or the other object.

Do not dispose of batteries in a fire as they may explode. Obey local regulations. Recycle when possible. Do not dispose as household waste.

Do not dismantle, cut, crush, bend, puncture, or otherwise damage the battery in any way. If a battery leaks, do not let liquid touch skin or eyes. If this happens, immediately flush the affected areas with water, or seek medical help. Do not modify, attempt to insert foreign objects into the battery, or immerse or expose it to water or other liquids. Batteries may explode if damaged.

Use the battery and charger for their intended purposes only. Improper use, or use of unapproved or incompatible batteries or chargers may present a risk of fire, explosion, or other hazard, and may invalidate any approval or warranty. If you believe the battery or charger is damaged, take it to a service centre or your phone dealer before continuing to use it. Never use a damaged battery or charger. Only use the charger indoors. Do not charge your device during a lightning storm.

SMALL CHILDREN

Your device and its accessories are not toys. They may contain small parts. Keep them out of the reach of small children.

MEDICAL DEVICES

Operation of radio transmitting equipment, including wireless phones, may interfere with inadequately shielded medical devices' function. Consult a physician or the medical device's manufacturer to determine if it is adequately shielded from external radio energy.

IMPLANTED MEDICAL DEVICES

To avoid potential interference, manufacturers of implanted medical devices (such as cardiac pacemakers, insulin pumps, and neurostimulators) recommend a minimum separation of 15.3 centimeters (6 inches) between a wireless device and the medical device. Persons who have such devices should:

- Always keep the wireless device more than 15.3 centimeters (6 inches) from the medical device.
- Not carry the wireless device in a breast pocket.
- Hold the wireless device to the ear opposite the medical device.
- Switch the wireless device off if there is

any reason to suspect that interference is taking place.

- Follow the manufacturer directions for the implanted medical device.

If you have any questions about using your wireless device with an implanted medical device, consult your health care provider.

HEARING



Warning: When you use the headset, your ability to hear outside sounds may be affected. Do not use the headset where it can endanger your safety.

Some wireless devices may interfere with some hearing aids.

PROTECT YOUR DEVICE FROM HARMFUL CONTENT

Your device may be exposed to viruses and other harmful content. Take the following precautions:

- Be cautious when opening messages. They may contain malicious software or otherwise be harmful to your device or computer.
- Be cautious when accepting connectivity requests or browsing the internet. Do not accept Bluetooth® connections from sources you do not trust.
- Install antivirus and other security software on any connected computer.
- If you access preinstalled bookmarks and links to third party internet sites, take the appropriate precautions. HMD Global does not endorse or assume liability for such sites.

VEHICLES

Radio signals may affect improperly installed or inadequately shielded electronic systems in vehicles. For more info, check with the manufacturer of your vehicle or its equipment. Only authorized personnel should install the device in a vehicle. Faulty installation may be dangerous and invalidate your warranty. Check regularly that all wireless device equipment in your vehicle is mounted and operating properly. Do not store or carry flammable or explosive materials in the same compartment as the device, its parts, or accessories. Do not place your device or accessories in the air bag deployment area.

POTENTIALLY EXPLOSIVE ENVIRONMENTS

Switch your device off in potentially explosive environments, such as near gasoline pumps. Sparks may cause an explosion or fire resulting in injury or death. Note restrictions in areas with fuel; chemical plants; or where blasting operations are in progress. Areas with a potentially explosive environment may not be clearly marked. These usually are areas where you are advised to switch your engine off, below deck on boats, chemical transfer or storage facilities, and where the air contains chemicals or particles. Check with the manufacturers of vehicles using liquefied petroleum gas (such as propane or butane) if this device can be safely used in their vicinity.

CERTIFICATION INFORMATION

This mobile device meets guidelines for exposure to radio waves.

Your mobile device is a radio transmitter and receiver. It is designed not to exceed the limits for exposure to radio waves (radio frequency electromagnetic fields), recommended by international guidelines from the independent scientific organization ICNIRP. These guidelines incorporate substantial safety margins that are intended to assure the protection of all persons regardless of age and health. The exposure guidelines are based on the Specific Absorption Rate (SAR), which is an expression of the amount of radio frequency (RF) power deposited in the head or body when the device is transmitting. The ICNIRP SAR limit for mobile devices is 2.0 W/kg averaged over 10 grams of tissue.

SAR tests are carried out with the device in standard operating positions, transmitting at its highest certified power level, in all its frequency bands.

This device meets RF exposure guidelines when used against the head or when positioned at least 5/8 inch (1.5 centimetres) away from the body. When a carry case, belt clip or other form of device holder is used for body-worn operation, it should not contain metal and should provide at least the above stated separation distance from the body.

To send data or messages, a good connection to the network is needed. Sending may be delayed until such a connection is available. Follow the separation distance instructions until the sending is finished.

During general use, the SAR values are usually well below the values stated above. This is because, for purposes of system efficiency and to minimize interference on the network, the operating power of your mobile device is automatically decreased when full power is not needed for the call. The lower the power output, the lower the SAR value.

Device models may have different versions and more than one value. Component and design changes may occur over time and some changes could affect SAR values.

For more info, go to www.sar-tick.com. Note that mobile devices may be transmitting even if you are not making a voice call.

The World Health Organization (WHO) has stated that current scientific information does not indicate the need for any special precautions when using mobile devices. If you are

interested in reducing your exposure, they recommend you limit your usage or use a hands-free kit to keep the device away from your head and body. For more information and explanations and discussions on RF exposure, go to the WHO website at www.who.int/health-topics/electromagnetic-fields#tab=tab_1.

Please refer to www.hmd.com/sar for the maximum SAR value of the device.

ABOUT DIGITAL RIGHTS MANAGEMENT

When using this device, obey all laws and respect local customs, privacy and legitimate rights of others, including copyrights. Copyright protection may prevent you from copying, modifying, or transferring photos, music, and other content.

COPYRIGHTS AND OTHER NOTICES

Copyrights

The availability of products, features, apps and services may vary by region. For more info, contact your dealer or your service provider. This device may contain commodities, technology or software subject to export laws and regulations from the US and other countries. Diversion contrary to law is prohibited.

The contents of this document are provided "as is". Except as required by applicable law, no warranties of any kind, either express or implied, including, but not limited to, the implied warranties of merchantability and fitness for a particular purpose, are made in relation to the accuracy, reliability or contents of this document. HMD Global reserves the right to revise this document or withdraw it at any time without prior notice.

To the maximum extent permitted by applicable law, under no circumstances shall HMD Global or any of its licensors be responsible for any loss of data or income or any special, incidental, consequential or indirect damages howsoever caused.

Reproduction, transfer or distribution of part or all of the contents in this document in any form without the prior written permission of HMD Global is prohibited. HMD Global operates a policy of continuous development. HMD Global reserves the right to make changes and improvements to any of the products described in this document without prior notice.

HMD Global does not make any representations, provide a warranty, or take any responsibility for the functionality, content, or end-user support of third-party apps provided with your device. By using an app, you acknowledge that the app is provided as is.

Downloading of maps, games, music and videos and uploading of images and videos may involve transferring large amounts of data. Your service provider may charge for the data transmission. The availability of particular products, services and features may vary by region. Please check with your local dealer for further details and availability of language options.

Certain features, functionality and product specifications may be network dependent and subject to additional terms, conditions, and charges.

Nokia 150 (2020) User Guide

All specifications, features and other product information provided are subject to change without notice.

HMD Global Privacy Policy, available at <http://www.hmd.com/privacy>, applies to your use of the device.

HMD Global Oy is the exclusive licensee of the Nokia brand for phones & tablets. Nokia is a registered trademark of Nokia Corporation.

The Bluetooth word mark and logos are owned by the Bluetooth SIG, Inc. and any use of such marks by HMD Global is under license.