

**NOKIA**

# **Nokia 225 4G**

## **User Guide**

# Table of Contents

<b>1</b>	<b>About this user guide</b>	<b>4</b>
<b>2</b>	<b>Get started</b>	<b>5</b>
	Keys and parts . . . . .	5
	Set up and switch on your phone . . . . .	6
	Charge your phone . . . . .	9
	Keypad . . . . .	9
<b>3</b>	<b>Calls, contacts, and messages</b>	<b>11</b>
	Calls . . . . .	11
	Contacts . . . . .	11
	Send messages . . . . .	12
<b>4</b>	<b>Personalize your phone</b>	<b>13</b>
	Change tones . . . . .	13
	Change the look of your home screen . . . . .	13
	Get the most out of the two SIM cards . . . . .	13
<b>5</b>	<b>Camera</b>	<b>14</b>
	Photos and videos . . . . .	14
<b>6</b>	<b>Internet and connections</b>	<b>15</b>
	Browse the web . . . . .	15
	Bluetooth® . . . . .	15
<b>7</b>	<b>Music</b>	<b>16</b>
	Music player . . . . .	16
	Listen to radio . . . . .	16
<b>8</b>	<b>Clock, calendar, and calculator</b>	<b>17</b>
	Set the time and date manually . . . . .	17
	Alarm clock . . . . .	17
	Calendar . . . . .	17
	Calculator . . . . .	17

<b>9 Empty your phone</b>	<b>19</b>
Remove private content from your phone . . . . .	19
<b>10 Product and safety information</b>	<b>20</b>
For your safety . . . . .	20
Emergency calls . . . . .	22
Take care of your device . . . . .	23
Recycle . . . . .	24
Crossed-out wheellie bin symbol . . . . .	24
Battery and charger information . . . . .	24
Small children . . . . .	25
Medical devices . . . . .	25
Implanted medical devices . . . . .	25
Hearing . . . . .	26
Protect your device from harmful content . . . . .	26
Vehicles . . . . .	26
Potentially explosive environments . . . . .	26
Certification information . . . . .	27
About Digital Rights Management . . . . .	27
Copyrights and other notices . . . . .	28

# 1 About this user guide



**Important:** For important information on the safe use of your device and battery, read “Product and safety information” before you take the device into use. To find out how to get started with your new device, read the user guide.

## 2 Get started

### KEYS AND PARTS

#### Your phone

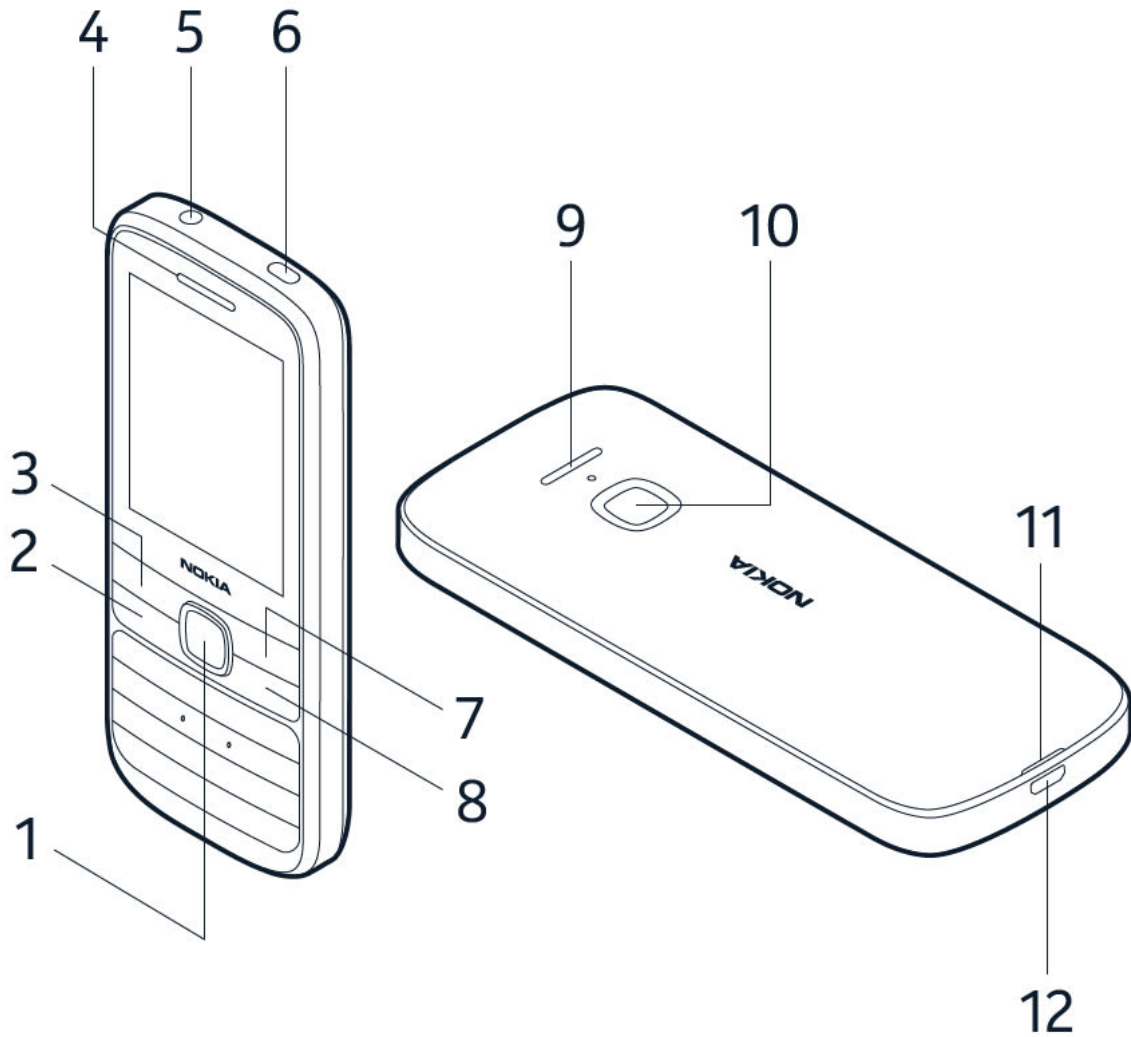

This user guide applies to the following models: TA-1276, TA-1296, TA-1279, TA-1289, TA-1282, TA-1316, TA-1321.

- |                       |                             |
|-----------------------|-----------------------------|
| 1. Scroll key         | 7. Right selection key      |
| 2. Call key           | 8. Power/End key            |
| 3. Left selection key | 9. Loudspeaker              |
| 4. Earpiece           | 10. Camera                  |
| 5. Headset connector  | 11. Back cover opening slot |
| 6. Flash              | 12. USB connector           |

Avoid touching the antenna area while the antenna is in use. Contact with antennas affects the communication quality and may reduce battery life due to higher power level during operation.

Do not connect to products that create an output signal, as this may damage the device. Do not connect any voltage source to the audio connector. If you connect an external device or headset, other than those approved for use with this device, to the audio connector, pay special attention to volume levels. Parts of the device are magnetic. Metallic materials may be attracted to the device. Do not place credit cards or other magnetic storage media near the device, because info stored on them may be erased.

Some of the accessories mentioned in this user guide, such as charger, headset, or data cable, may be sold separately.



**Note:** You can set the phone to ask for a security code to protect your privacy and personal data. Select **Menu** >  > **Security** > **Keyguard** > **Security code**. Note, however, that you need to remember the code, as HMD Global is not able to open or bypass it.

## SET UP AND SWITCH ON YOUR PHONE

### Nano-SIM



**Important:** This device is designed to be used with a nano-SIM card only. Use of incompatible SIM cards may damage the card or the device, and may corrupt data stored on the card.



**Note:** Switch the device off and disconnect the charger and any other device before removing any covers. Avoid touching electronic components while changing any covers. Always store and use the device with any covers attached.

## Open the back cover

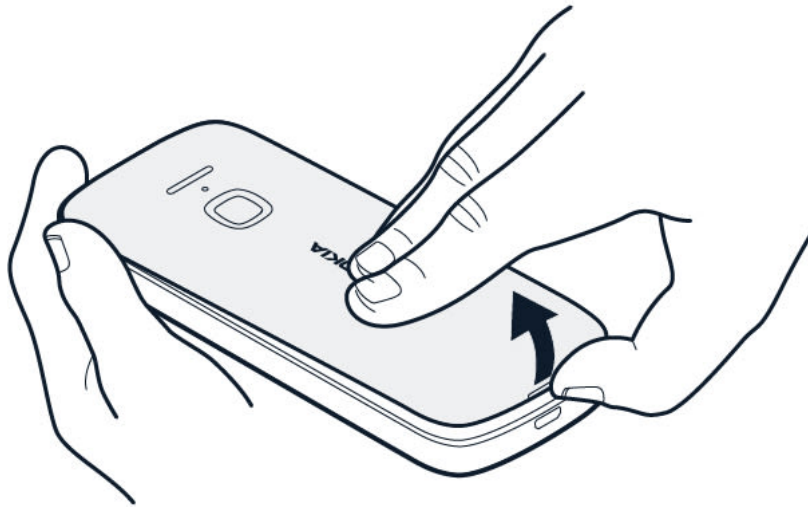

1. Put your fingernail in the small slot at the bottom of the phone, lift and remove the cover.
2. If the battery is in the phone, lift it out.

## Insert the SIM card

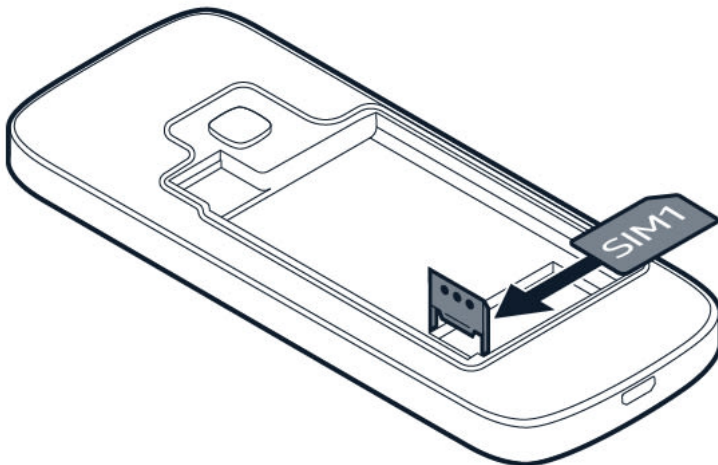

1. Slide the SIM card holder to the left and open it up.
2. Place the nano-SIM in the SIM slot face down.
3. Close down the holder, and slide it to the right to lock it in place.

## Insert the second SIM

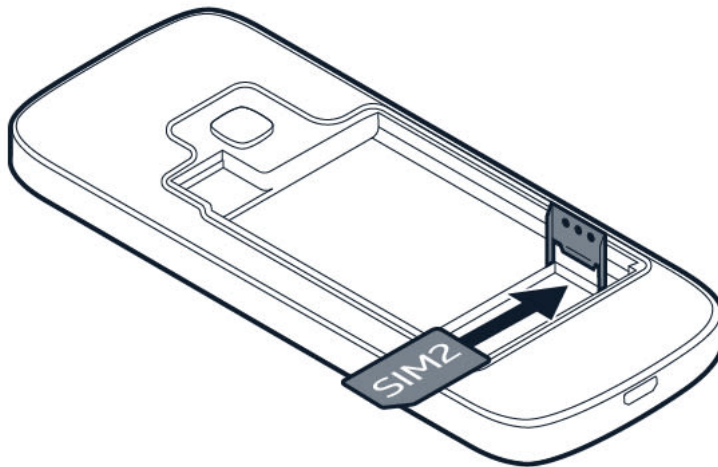

1. Slide the SIM card holder of the SIM2 slot to the right and open it up.
2. Place the nano-SIM in the SIM2 slot face down.
3. Close down the holder, and slide it to the left to lock it in place. Both SIM cards are available at the same time when the device is not being used, but while one SIM card is active, for example, making a call, the other may be unavailable.



**Tip:** To find out if your phone can use 2 SIM cards, see the label on the sales box. If there are 2 IMEI codes on the label, you have a dual-SIM phone.

## Insert the memory card

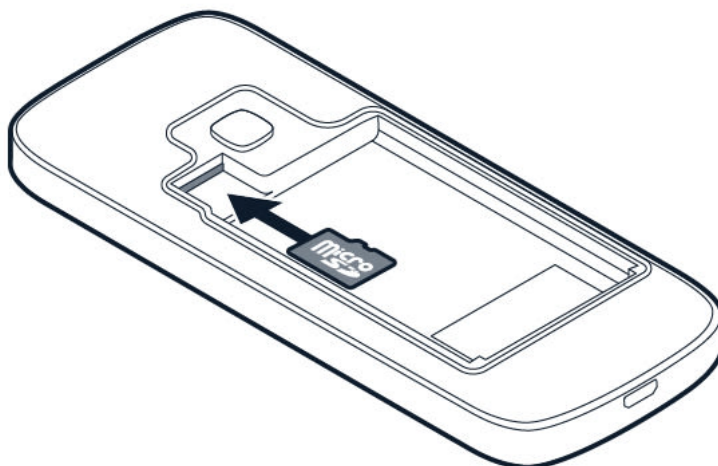

1. Slide the memory card in the memory card slot.
2. Put back the battery.
3. Put back the back cover.

## Switch on your phone

Press and hold .

## CHARGE YOUR PHONE

Your battery has been partially charged at the factory, but you may need to recharge it before you can use your phone.

### Charge the battery

1. Plug the charger into a wall outlet.
2. Connect the charger to the phone. When done, unplug the charger from the phone, then from the wall outlet.

If the battery is completely discharged, it may take several minutes before the charging indicator is displayed.





**Tip:** You can use USB charging when a wall outlet is not available. Data can be transferred while charging the device. The efficiency of USB charging power varies significantly, and it may take a long time for charging to start and the device to start functioning. Make sure your computer is switched on.

## KEYPAD

### Use the phone keys

- To see the apps and features of your phone, on the home screen, select **Menu**.
- To go to an app or feature, press the scroll key up, down, left, or right. To open the app or feature, press the scroll key.

### Lock the keypad

To avoid accidentally pressing the keys, lock the keypad: press . To unlock the keypad, press the scroll key, and select **Unlock** > .

## Write with the keypad

Press a key and then use the scroll key to select the letter you need.

To type in a space press **0**.

To type in a special character or punctuation mark, select **≡** > **Insert options** > **Insert symbol**.

To switch between character cases, press **#** repeatedly.

To type in a number, press a number key and use the scroll key to select the number.

## 3 Calls, contacts, and messages

### CALLS

#### Make a call

Learn how to make a call with your new phone.

1. Type in the phone number. To type in the + character, used for international calls, press \* twice.
2. Press the call key. If asked, select which SIM to use.
3. To end the call, press the end key.

#### Answer a call

Press .



### CONTACTS

#### Add a contact

1. Select **Menu** >  > **+ New contact**.
2. Write the name, and type in the number.
3. Select **←** > **OK**.

To add more contacts, select  > **Add new contact**.

#### Save a contact from call log

1. Select **Menu** > .
2. Scroll to the number you want to save, select  > **Add to Contacts** > **New contact**.
3. Add the contact's name, check that the phone number is correct, and select **←** > **OK**.



#### Call a contact

You can call a contact directly from the contacts list.

Select **Menu** > , scroll to the contact you want to call, and press the call key.

## SEND MESSAGES

### Write and send messages

1. Select **Menu** >  > **+ New message**.
2. In the Recipients field, enter the number of the recipient, or select  > **Contacts** to add recipients from your contacts list.
3. Write the message on the message field.
4. To insert smileys or symbols to the message, select  > **Insert options** > **Insert smiley** or **Insert symbol**.
5. Select **Send**.

## 4 Personalize your phone

### CHANGE TONES

#### Set new tones

1. Select **Menu** >  > **Personalisation** > **Sounds**.
2. Select the tone you want to change.
3. Scroll to the tone that you want and select **Select**.

### CHANGE THE LOOK OF YOUR HOME SCREEN

#### Choose a new wallpaper

You can change the background of your home screen.

1. Select **Menu** >  > **Personalisation** > **Lock screen background** > **Wallpapers**.
2. Scroll to the wallpaper you want, and select **Select**.
3. If you like the wallpaper, select ✓.

### GET THE MOST OUT OF THE TWO SIM CARDS

Your phone can have two SIM cards, and you can use them for different purposes.

#### Select which SIM card to use

Select **Menu** >  > **Connectivity** > **Dual SIM**.

- To choose which SIM to use for calls, select **Preferred SIM for calls**.
- To choose which SIM to use for messages, select **Preferred SIM for messages**.
- To choose which SIM to use for mobile data, select **Mobile data connection** > **Preferred SIM**.





**Tip:** You can rename your SIM cards to make it easy to distinguish between them. Select **Menu** >  > **Connectivity** > **Dual SIM** > **SIM settings**. Select a SIM and **SIM name**.

## 5 Camera

### PHOTOS AND VIDEOS

You don't need a separate camera when your phone has all you need for capturing memories.

#### Take a photo





1. Select **Menu** > .
2. To take a photo, select .

To see the photo you just took, select  > **Gallery**.

#### Options for the camera

Select **Menu** >  > , and select the option you want, such as **Effects** or **Timer**.

#### Record a video

1. To switch the video camera on, select **Menu** >  and scroll to .
2. To start recording, select .
3. To stop recording, select .

To see the video you just recorded, select **Menu** > **Videos**.

## 6 Internet and connections

### BROWSE THE WEB

#### Connect to the internet

Note that the browser may vary by your region and work differently.

1. Select **Menu** > .
2. Write a web address, and press **OK**.

### BLUETOOTH®

Connect your phone to other devices with Bluetooth.

#### Switch on Bluetooth

1. Select **Menu** >  > **Connectivity** > **Bluetooth**.
2. Switch **Bluetooth** on.
3. Select **Devices found** and the Bluetooth device you want to connect to.

## 7 Music

### MUSIC PLAYER

You can listen to your MP3 music files with the music player.

#### Listen to music

To play music, you need to store the music files on a memory card or on the phone memory.





1. Select **Menu** > .
2. Select **Songs** to see all your saved music.
3. Scroll to a song and select **Play**.

You can also create your own playlists.

To adjust the volume, scroll up or down.

### LISTEN TO RADIO

#### Listen to your favorite radio stations on your phone

Select **Menu** > . Your phone searches for stations automatically when you turn the radio on. To change the volume, scroll up or down. To save a station, select  > **Add to favourites**. To switch to a saved station, select  > **Favourites**, and select the station. To close the radio, select  > **Close radio**.

## 8 Clock, calendar, and calculator

### SET THE TIME AND DATE MANUALLY

#### Change the time and date



1. Select **Menu** >  > **Time & language** > **Date and time**.
2. Switch **Auto-update** off.
3. To set the time, select **Time** and enter the time.
4. To set the date, select **Date** and enter the date.
5. Select **Save**.

### ALARM CLOCK

Learn how to use the alarm clock to wake up and get to places on time.



#### Set an alarm

No clock around? Use your phone as an alarm clock.

1. Select **Menu** > .
2. Select **+ New alarm** and enter the alarm time and other details.
3. Select  > **Save**.

### CALENDAR

#### Add a calendar event

1. Select **Menu** > .
2. Scroll to a date and select  > **Add new event**.
3. Enter the event details, and select **Save**.

### CALCULATOR

Learn how to add, subtract, multiply and divide with your phone calculator.

## How to calculate

1. Select **Menu** > .
2. Enter the first factor of your calculation, use the scroll key to select the operation, and enter the second factor.
3. Press the scroll key to get the result of the calculation.

Select  to empty the number fields.



## 9 Empty your phone



### REMOVE PRIVATE CONTENT FROM YOUR PHONE



If you buy a new phone, or otherwise want to dispose of or recycle your phone, here's how you can remove your personal info and content. Note that it is your responsibility to remove all private content.

#### Remove content from your phone

When removing private content from your phone, pay attention to whether you are removing content from the phone memory or the SIM card.

To remove messages, select **Menu** > . Select  > **Delete conversations**, select all the message threads and .

To remove contacts, select **Menu** > . Select  > **Delete contacts**, select all the contacts and .

To remove your call info, select **Menu** > . Select  > **Delete all** > **OK**.

Check that all your personal content has been removed.

## 10 Product and safety information

### FOR YOUR SAFETY

Read these simple guidelines. Not following them may be dangerous or against local laws and regulations. For further info, read the complete user guide.

#### SWITCH OFF IN RESTRICTED AREAS



Switch the device off when mobile device use is not allowed or when it may cause interference or danger, for example, in aircraft, in hospitals or near medical equipment, fuel, chemicals, or blasting areas. Obey all instructions in restricted areas.

#### ROAD SAFETY COMES FIRST



Obey all local laws. Always keep your hands free to operate the vehicle while driving. Your first consideration while driving should be road safety.

#### INTERFERENCE



All wireless devices may be susceptible to interference, which could affect performance.

## **AUTHORIZED SERVICE**



Only authorized personnel may install or repair this product.

## **BATTERIES, CHARGERS, AND OTHER ACCESSORIES**



Use only batteries, chargers, and other accessories approved by HMD Global Oy for use with this device. Do not connect incompatible products.

## **KEEP YOUR DEVICE DRY**



If your device is water-resistant, see its IP rating in the device's technical specifications for more detailed guidance.

## PROTECT YOUR HEARING



To prevent possible hearing damage, do not listen at high volume levels for long periods. Exercise caution when holding your device near your ear while the loudspeaker is in use.

## SAR



This device meets RF exposure guidelines when used either in the normal use position against the ear or when positioned at least 1.5 centimetres (5/8 inch) away from the body. The specific maximum SAR values can be found in the Certification Information (SAR) section of this user guide. For more information, see the Certification Information (SAR) section of this user guide or go to [www.sar-tick.com](http://www.sar-tick.com).

## EMERGENCY CALLS

 **Important:** Connections in all conditions cannot be guaranteed. Never rely solely on any wireless phone for essential communications like medical emergencies.

Before making the call:

- Switch the phone on.
- If the phone screen and keys are locked, unlock them.
- Move to a place with adequate signal strength.

1. Press the end key repeatedly, until the home screen is shown.

2. Type in the official emergency number for your present location. Emergency call numbers vary by location.
3. Press the call key.
4. Give the necessary info as accurately as possible. Do not end the call until given permission to do so.

You may also need to do the following:

- Put a SIM card in the phone.
- If your phone asks for a PIN code, type in the official emergency number for your present location, and press the call key.
- Switch the call restrictions off in your phone, such as call barring, fixed dialling, or closed user group.

## TAKE CARE OF YOUR DEVICE

Handle your device, battery, charger and accessories with care. The following suggestions help you keep your device operational.

- Keep the device dry. Precipitation, humidity, and all types of liquids or moisture can contain minerals that corrode electronic circuits.
- Do not use or store the device in dusty or dirty areas.
- Do not store the device in high temperatures. High temperatures may damage the device or battery.
- Do not store the device in cold temperatures. When the device warms to its normal temperature, moisture can form inside the device and damage it.
- Do not open the device other than as instructed in the user guide.
- Unauthorized modifications may damage the device and violate regulations governing radio devices.
- Do not drop, knock, or shake the device or the battery. Rough handling can break it.
- Only use a soft, clean, dry cloth to clean the surface of the device.
- Do not paint the device. Paint can prevent proper operation.
- Keep the device away from magnets or magnetic fields.
- To keep your important data safe, store it in at least two separate places, such as your device, memory card, or computer, or write down important info.

During extended operation, the device may feel warm. In most cases, this is normal. To avoid getting too warm, the device may automatically slow down, close apps, switch off charging, and if necessary, switch itself off. If the device is not working properly, take it to the nearest authorized service facility.

## RECYCLE



Always return your used electronic products, batteries, and packaging materials to dedicated collection points. This way you help prevent uncontrolled waste disposal and promote the recycling of materials. Electrical and electronic products contain a lot of valuable materials, including metals (such as copper, aluminum, steel, and magnesium) and precious metals (such as gold, silver, and palladium). All materials of the device can be recovered as materials and energy.

## CROSSED-OUT WHEELIE BIN SYMBOL

**Crossed-out wheelie bin symbol**



The crossed-out wheelie-bin symbol on your product, battery, literature, or packaging reminds you that all electrical and electronic products and batteries must be taken to separate collection at the end of their working life. Remember to remove personal data from the device first. Do not dispose of these products as unsorted municipal waste: take them for recycling. For info on your nearest recycling point, check with your local waste authority, or read about HMD's take-back program and its availability in your country at [www.hmd.com/phones/support/topics/recycle](http://www.hmd.com/phones/support/topics/recycle).

## BATTERY AND CHARGER INFORMATION

**Battery and charger safety info**

To unplug a charger or an accessory, hold and pull the plug, not the cord.

When your charger is not in use, unplug it. If left unused, a fully charged battery will lose its charge over time.

Always keep the battery between 59°F and 77°F (15°C and 25°C) for optimal performance. Extreme temperatures reduce the capacity and lifetime of the battery. A device with a hot or cold battery may not work temporarily. Accidental short-circuiting can happen when a metallic object touches the metal strips on the battery. This may damage the battery or the other object.

Do not dispose of batteries in a fire as they may explode. Obey local regulations. Recycle when possible. Do not dispose as household waste.

Do not dismantle, cut, crush, bend, puncture, or otherwise damage the battery in any way. If a battery leaks, do not let liquid touch skin or eyes. If this happens, immediately flush the affected areas with water, or seek medical help. Do not modify, attempt to insert foreign objects into the battery, or immerse or expose it to water or other liquids. Batteries may explode if damaged.

Use the battery and charger for their intended purposes only. Improper use, or use of unapproved or incompatible batteries or chargers may present a risk of fire, explosion, or other hazard, and may invalidate any approval or warranty. If you believe the battery or charger is damaged, take it to a service centre or your phone dealer before continuing to use it. Never use a damaged battery or charger. Only use the charger indoors. Do not charge your device during a lightning storm.

## SMALL CHILDREN

Your device and its accessories are not toys. They may contain small parts. Keep them out of the reach of small children.

## MEDICAL DEVICES

Operation of radio transmitting equipment, including wireless phones, may interfere with inadequately shielded medical devices' function. Consult a physician or the medical device's manufacturer to determine if it is adequately shielded from external radio energy.

## IMPLANTED MEDICAL DEVICES

To avoid potential interference, manufacturers of implanted medical devices (such as cardiac pacemakers, insulin pumps, and neurostimulators) recommend a minimum separation of 15.3 centimeters (6 inches) between a wireless device and the medical device. Persons who have such devices should:

- Always keep the wireless device more than 15.3 centimeters (6 inches) from the medical device.
- Not carry the wireless device in a breast pocket.
- Hold the wireless device to the ear opposite the medical device.
- Switch the wireless device off if there is

any reason to suspect that interference is taking place.

- Follow the manufacturer directions for the implanted medical device.

If you have any questions about using your wireless device with an implanted medical device, consult your health care provider.

## HEARING



**Warning:** When you use the headset, your ability to hear outside sounds may be affected. Do not use the headset where it can endanger your safety.

Some wireless devices may interfere with some hearing aids.

## PROTECT YOUR DEVICE FROM HARMFUL CONTENT

Your device may be exposed to viruses and other harmful content. Be cautious when opening messages. They may contain malicious software or otherwise be harmful to your device.

## VEHICLES

Radio signals may affect improperly installed or inadequately shielded electronic systems in vehicles. For more info, check with the manufacturer of your vehicle or its equipment. Only authorized personnel should install the device in a vehicle. Faulty installation may be dangerous and invalidate your warranty. Check regularly that all wireless device equipment in your vehicle is mounted and operating properly. Do not store or carry flammable or explosive materials in the same compartment as the device, its parts, or accessories. Do not place your device or accessories in the air bag deployment area.

## POTENTIALLY EXPLOSIVE ENVIRONMENTS

Switch your device off in potentially explosive environments, such as near gasoline pumps. Sparks may cause an explosion or fire resulting in injury or death. Note restrictions in areas with fuel; chemical plants; or where blasting operations are in progress. Areas with a potentially explosive environment may not be clearly marked. These usually are areas where you are advised to switch your engine off, below deck on boats, chemical transfer or storage facilities, and where the air contains chemicals or particles. Check with the manufacturers of vehicles using liquefied petroleum gas (such as propane or butane) if this device can be safely used in their vicinity.

## CERTIFICATION INFORMATION

### **This mobile device meets guidelines for exposure to radio waves.**

Your mobile device is a radio transmitter and receiver. It is designed not to exceed the limits for exposure to radio waves (radio frequency electromagnetic fields), recommended by international guidelines from the independent scientific organization ICNIRP. These guidelines incorporate substantial safety margins that are intended to assure the protection of all persons regardless of age and health. The exposure guidelines are based on the Specific Absorption Rate (SAR), which is an expression of the amount of radio frequency (RF) power deposited in the head or body when the device is transmitting. The ICNIRP SAR limit for mobile devices is 2.0 W/kg averaged over 10 grams of tissue.

SAR tests are carried out with the device in standard operating positions, transmitting at its highest certified power level, in all its frequency bands.

This device meets RF exposure guidelines when used against the head or when positioned at least 5/8 inch (1.5 centimetres) away from the body. When a carry case, belt clip or other form of device holder is used for body-worn operation, it should not contain metal and should provide at least the above stated separation distance from the body.

To send data or messages, a good connection to the network is needed. Sending may be delayed until such a connection is available. Follow the separation distance instructions until the sending is finished.

During general use, the SAR values are usually well below the values stated above. This is because, for purposes of system efficiency and to minimize interference on the network, the operating power of your mobile device is automatically decreased when full power is not needed for the call. The lower the power output, the lower the SAR value.

Device models may have different versions and more than one value. Component and design changes may occur over time and some changes could affect SAR values.

For more info, go to [www.sar-tick.com](http://www.sar-tick.com). Note that mobile devices may be transmitting even if you are not making a voice call.

The World Health Organization (WHO) has stated that current scientific information does not indicate the need for any special precautions when using mobile devices. If you are interested in reducing your exposure, they recommend you limit your usage or use a hands-free kit to keep the device away from your head and body. For more information and explanations and discussions on RF exposure, go to the WHO website at [www.who.int/health-topics/electromagnetic-fields#tab=tab\\_1](http://www.who.int/health-topics/electromagnetic-fields#tab=tab_1).

Please refer to [www.hmd.com/sar](http://www.hmd.com/sar) for the maximum SAR value of the device.

## ABOUT DIGITAL RIGHTS MANAGEMENT

When using this device, obey all laws and respect local customs, privacy and legitimate rights of others, including copyrights. Copyright protection may prevent you from copying, modifying, or transferring photos, music, and other content.

## COPYRIGHTS AND OTHER NOTICES

### Copyrights

The availability of products, features, apps and services may vary by region. For more info, contact your dealer or your service provider. This device may contain commodities, technology or software subject to export laws and regulations from the US and other countries. Diversion contrary to law is prohibited.

The contents of this document are provided "as is". Except as required by applicable law, no warranties of any kind, either express or implied, including, but not limited to, the implied warranties of merchantability and fitness for a particular purpose, are made in relation to the accuracy, reliability or contents of this document. HMD Global reserves the right to revise this document or withdraw it at any time without prior notice.

To the maximum extent permitted by applicable law, under no circumstances shall HMD Global or any of its licensors be responsible for any loss of data or income or any special, incidental, consequential or indirect damages howsoever caused.

Reproduction, transfer or distribution of part or all of the contents in this document in any form without the prior written permission of HMD Global is prohibited. HMD Global operates a policy of continuous development. HMD Global reserves the right to make changes and improvements to any of the products described in this document without prior notice.

HMD Global does not make any representations, provide a warranty, or take any responsibility for the functionality, content, or end-user support of third-party apps provided with your device. By using an app, you acknowledge that the app is provided as is.

Downloading of maps, games, music and videos and uploading of images and videos may involve transferring large amounts of data. Your service provider may charge for the data transmission. The availability of particular products, services and features may vary by region. Please check with your local dealer for further details and availability of language options.

Certain features, functionality and product specifications may be network dependent and subject to additional terms, conditions, and charges.

All specifications, features and other product information provided are subject to change without notice.

HMD Global Privacy Policy, available at <http://www.hmd.com/privacy>, applies to your use of the device.

HMD Global Oy is the exclusive licensee of the Nokia brand for phones & tablets. Nokia is a registered trademark of Nokia Corporation.

The Bluetooth word mark and logos are owned by the Bluetooth SIG, Inc. and any use of such marks by HMD Global is under license.

This product includes open source software. For applicable copyright and other notices, permissions, and acknowledgements, select `*#6774#` on the home screen.