

NOKIA

Nokia 7 Plus

User Guide

Table of Contents

1	About this user guide	5
2	Get started	6
	Keep your phone up to date	6
	Keys and parts	6
	Insert or remove SIM and memory card	7
	Charge your phone	8
	Switch on and set up your phone	9
	Dual SIM settings	9
	Setting up fingerprint ID	10
	Lock or unlock your phone	10
	Use the touch screen	10
3	Basics	14
	Personalise your phone	14
	Open and close an app	14
	Notifications	15
	Control volume	16
	Screenshots	16
	Battery life	16
	Save on data roaming costs	17
	Write text	18
	Date and time	19
	Clock and alarm	20
	Calculator	21
	Accessibility	21
	Notes	22

4	Connect with your friends and family	23
	Calls	23
	Contacts	23
	Send and receive messages	24
	Get social	25
5	Camera	26
	Camera basics	26
	Record a video	27
	Use your camera like a pro	28
	Save your photos and videos to a memory card	29
	Your photos and videos	30
6	Internet and connections	31
	Activate Wi-Fi	31
	Use a mobile data connection	31
	Browse the web	32
	Close a connection	33
	Bluetooth®	34
	NFC	36
	VPN	37
7	Apps and services	38
	AppStore and preloaded apps	38
8	Software updates and backups	40
	Update your phone software	40
	Back up your data	40
	Restore original settings and remove private content from your phone	40
	Storage	41

9 Protect your phone	42
Protect your phone with your fingerprint	42
Change your SIM PIN	42
Access codes	43
10 Product and safety information	44
Copyrights and notices	44

1 About this user guide



Important: For important information on the safe use of your device and battery, read “Product and safety information” before you take the device into use. To find out how to get started with your new device, read the user guide.

2 Get started

KEEP YOUR PHONE UP TO DATE

Your phone software

Keep your phone up to date and accept available software updates to get new and enhanced features for your phone. Updating the software may also improve your phone's performance.

KEYS AND PARTS

Explore the keys and parts of your new phone.

Your phone

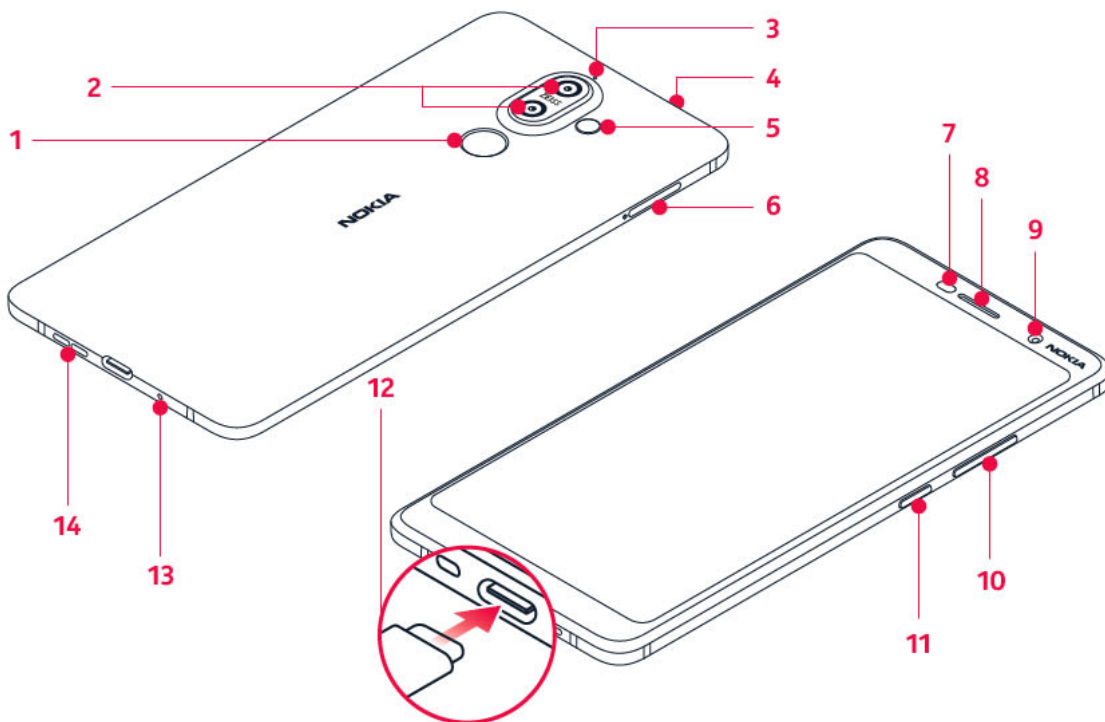

This user guide applies to following model: TA-1062.

- | | |
|-----------------------|-------------------------------|
| 1. Fingerprint sensor | 5. Flash |
| 2. Main cameras | 6. SIM card/MicroSD card tray |
| 3. Microphone | 7. Proximity sensor |
| 4. Audio connector | 8. Earpiece |

- 9. Front camera
- 10. Volume keys
- 11. Power/Lock key
- 12. Charger connector
- 13. Microphone
- 14. Loudspeaker

Some of the accessories mentioned in this user guide, such as charger, headset, or data cable, may be sold separately.

! **Important:** It is recommended to use the protective cover included in the sales box which protects the device if dropped.

Parts and connectors, magnetism

Do not connect to products that create an output signal, as this may damage the device. Do not connect any voltage source to the audio connector. If you connect an external device or headset, other than those approved for use with this device, to the audio connector, pay special attention to volume levels.

Parts of the device are magnetic. Metallic materials may be attracted to the device. Do not place credit cards or other magnetic stripe cards near the device for extended periods of time, since the cards may be damaged.

INSERT OR REMOVE SIM AND MEMORY CARD

Insert SIM and memory card

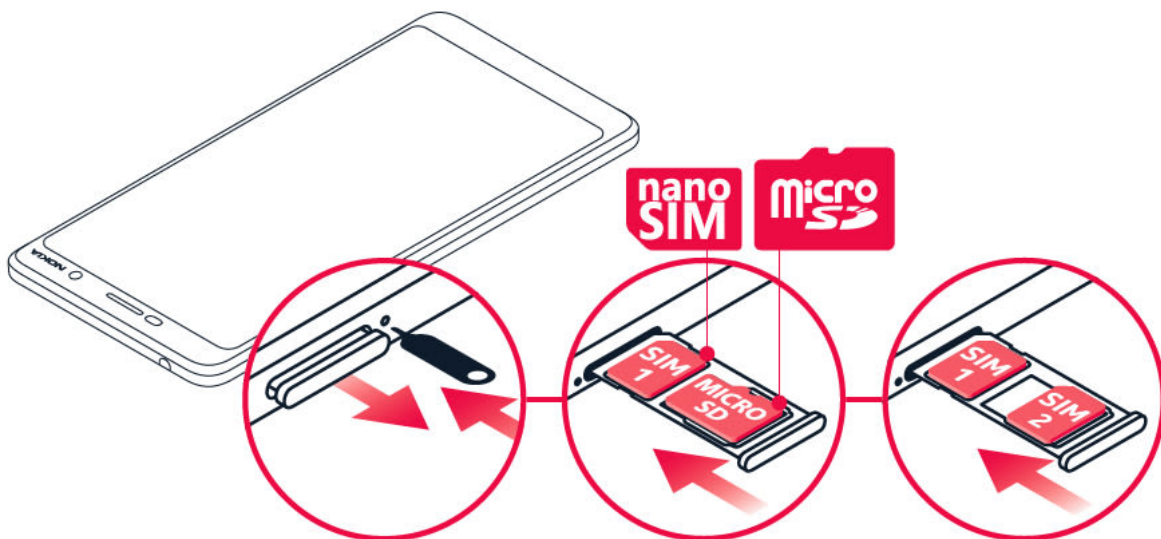

1. To open the SIM card tray, insert the tray opener in the hole next to the tray and push.

- Put the nano-SIM into the slot 1 located on the tray with the contact area face down. If you have a second SIM, put it into the slot 2, or, if you have a memory card, put the card into the memory card slot located in the SIM slot.
- Slide the SIM and memory card tray back into place.¹

Use only compatible memory cards approved for use with this device. Incompatible cards may damage the card and the device and corrupt data stored on the card.

“ ”

- Note:** If you have a dual SIM phone with only one SIM tray, you cannot use two SIM cards and a memory card at the same time.
- Important:** Network access license is needed for verifying that your phone is authentic, please keep it in a safe place.

Remove the SIM and memory cards

Open the SIM and memory card tray, remove the cards, and slide the tray back into its slot.

¹ Use only original nano-SIM cards. Use of incompatible SIM cards may damage the card or the device, and may corrupt data stored on the card.

CHARGE YOUR PHONE

Charge the battery

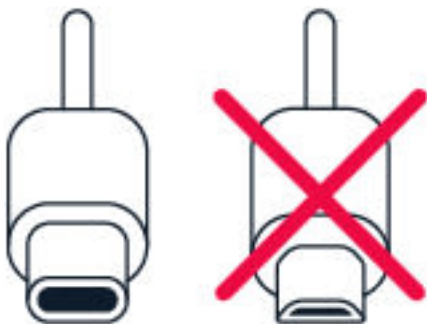

- Plug a compatible charger into a power socket.
- Connect the cable to your phone.

Your phone supports the USB-C cable. You can also charge your phone from a computer with a USB cable, but it may take longer.

If the battery is completely discharged, it may take several minutes before the charging indicator is displayed.

SWITCH ON AND SET UP YOUR PHONE

When you switch your phone on for the first time, your phone guides you to set up your network connections and phone settings.

Switch on your phone

1. To switch on your phone, press and hold the power key until the phone vibrates.
2. When the phone is switched on, choose your language and region.
3. Follow the instructions shown on your phone.

DUAL SIM SETTINGS

You can have 2 SIMs in your phone, for example, one for your work and one for your personal use.



Note: On dual SIM capable devices, both SIM1 and SIM2 slots support 4G networks. However, if your SIM1 and SIM2 are both LTE SIM cards, the primary SIM supports 4G/3G/2G networks, while the secondary SIM can only support 3G/2G. For more information on your SIM cards, contact your service provider.

Choose which SIM to use

When, for example, making a call, you can choose which SIM to use by tapping the corresponding SIM 1 or SIM 2 button after you dial the number.

Your phone shows the network status for both SIMs separately. Both SIM cards are available at the same time when the device is not being used, but while one SIM card is active, when, for example, making a call, the other may be unavailable.

Manage your SIMs

Don't want work to interfere with your free time? Or do you have a cheaper data connection on one SIM? You can decide which SIM you want to use.

Tap **Settings** > **Network & Internet** > **SIM Cards** .

Rename a SIM card

Tap the SIM you want to rename, and type in the name you want.

Select which SIM to use for calls or data connection

Under **Preferred SIM for**, tap the setting you want to change and select the SIM.

SETTING UP FINGERPRINT ID

You can unlock your phone with just a touch of your finger. Set up your fingerprint ID for extra security.

Add a fingerprint

1. Tap **Settings** > **Security & Location** > **Fingerprint**. If you don't have screen lock set up on your phone, tap **Screen lock**.
2. Select which backup unlocking method you want to use for the lock screen and follow the instructions shown on your phone.

LOCK OR UNLOCK YOUR PHONE

Lock your phone

If you want to avoid accidentally making a call when your phone is in your pocket or bag, you can lock your keys and screen.

To lock your keys and screen, press the power key.

Unlock the keys and screen

Press the power key, and swipe up across the screen. If asked, provide additional credentials.

USE THE TOUCH SCREEN

Important: Avoid scratching the touch screen. Never use an actual pen, pencil, or other sharp object on the touch screen.

Tap and hold to drag an item



Place your finger on the item for a couple of seconds and slide your finger across the screen.

Swipe



Place your finger on the screen and slide your finger in the direction you want.

Scroll through a long list or menu

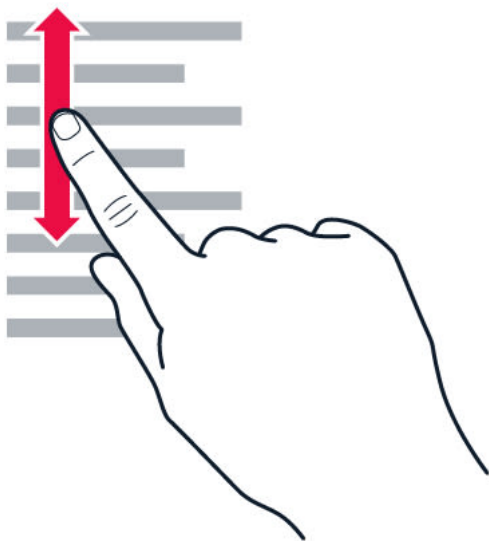

Slide your finger quickly in a flicking motion up or down the screen and lift your finger. To stop the scrolling, tap the screen.

Zoom in or out

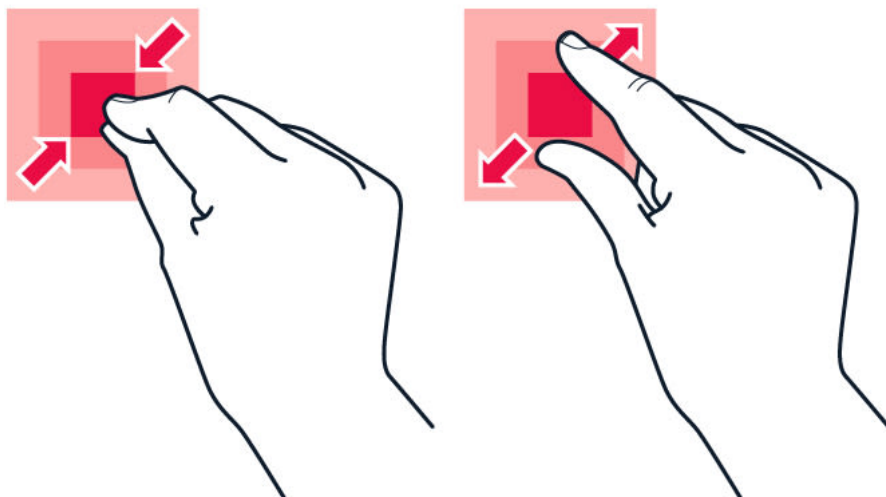

Place 2 fingers on an item, such as a map, photo, or web page, and slide your fingers apart or together.

Lock the screen orientation

The screen rotates automatically when you turn the phone 90°.

To lock the screen in portrait mode, swipe down from the top of the screen and tap **Auto-rotate** to switch to **Portrait**.

Use the navigation keys



To see which apps you have open, tap the Overview key .

To switch to another app, tap the app you want. To close an app, tap the  icon next to it.

To go back to the previous screen, tap the Back key . Your phone remembers all the apps and websites you've visited since the last time your screen was locked.

To go to the home screen, tap the Home key . The app you were in stays open in the background.

Open two apps at once

For easier navigation between apps, press and hold the overview  key to divide the screen between two apps. To go back to normal view, press and hold the overview  key again.

3 Basics

PERSONALISE YOUR PHONE

Learn how to personalise the home screen and how to change ringtones.

Change your wallpaper

Tap **Settings** > **Display** > **Wallpaper**.

Change your phone ringtone

1. Tap **Settings** > **Sound**.
2. Tap **Phone ringtone (SIM1)** or > **Phone ringtone (SIM2)** to select the ringtone for respective SIMs.

Change your message notification sound



Tap **Settings** > **Sound** > **Advanced** > **Default notification sound**.

OPEN AND CLOSE AN APP

Open an app

On the home screen, tap an app icon to open it. To open one of the apps running in the background, tap , and select the app.

Close an app

Tap , and then tap  on the app you want to close.

Find your apps

On the home screen, swipe left to see all your apps.

Close all running apps

Tap  >  **CLEAR ALL**.

NOTIFICATIONS

Stay in touch with what's happening on your phone with notifications.

Use the notification panel

When you receive new notifications, such as messages or missed calls, indicator icons appear on the status bar at the top of the screen. To see more information about the notifications, drag the status bar down. To close the view, swipe up on the screen.

To open the notification panel, drag the status bar down. To close the notification panel, swipe up on the screen.

To change the notification settings for an app, tap **Settings** > **Apps & notifications** > **Notifications** > **App notifications** and tap the app name to open the app settings. You can turn notifications on or off for each app individually. To see the apps that are not allowed to send notifications, tap **All apps** > **Apps: Turned off**.



Tip: To see notification dots, tap **Settings** > **Apps & notifications** > **Notifications** and switch **Allow notification dots** on. A small dot will appear on the app icon if you've got a notification, but haven't attended to it yet. Tap and hold the icon to see available options. You can tap the notification to open it or swipe to dismiss it.

Use the quick setting icons

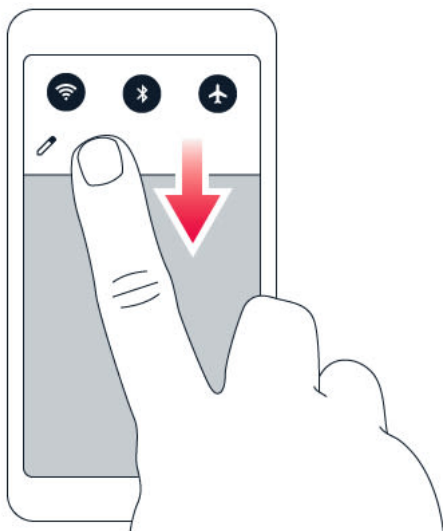

To activate certain features, tap the quick settings icons on the notification panel. To see more icons, drag the menu down.

To rearrange the icons, tap , tap and hold an icon, and then drag it to another location.

CONTROL VOLUME

Change the volume

If you have trouble hearing your phone ringing in noisy environments, or calls are too loud, you can change the volume to your liking by using the volume keys on the side of your phone.

Do not connect to products that create an output signal, as this may damage the device. Do not connect any voltage source to the audio connector. If you connect an external device or headset, other than those approved for use with this device, to the audio connector, pay special attention to volume levels.

Change the volume for media and apps

Press a volume key on the side of your phone to see the volume status bar, tap , and drag the slider on the volume bar for media and apps left or right.

Set the phone to silent

To set the phone to silent, press and hold the volume down key and then press the key again. The first press sets the phone to vibrate only and the second press sets it to silent.



Tip: Don't want to keep your phone in silent mode, but can't answer right now? To silence an incoming call, press the Volume down key. You can also set your phone to mute the ringing when you pick the phone up: tap **Settings** > **System** > **Gestures** > **Mute on pickup**, and switch to on.

If you want to be able to reject an incoming call by turning over the phone, tap **Settings** > **System** > **Gestures** > **Turn over to reject call**, and switch to on.

SCREENSHOTS

Take a screenshot

To take a screenshot, open the notification panel, and drag the status bar down. Tap **Screen capture**. You can view the captured images in Gallery.

It is not possible to capture a screenshot while using some apps and features.

BATTERY LIFE

Extend battery life

To save power:

1. Always charge the battery fully.
2. Mute unnecessary sounds, such as touch sounds. Tap **Settings** > **Sound** > **Advanced**, and under **Other sounds and vibrations**, select which sounds to keep.
3. Use wired headphones, rather than the loudspeaker.
4. Set the phone screen to switch off after a short time. Tap **Settings** > **Display** > **Advanced** > **Sleep** and select the time.
5. Tap **Settings** > **Display** > **Brightness level**. To adjust the brightness, drag the brightness level slider. Make sure that **Adaptive brightness** is disabled.
6. Stop apps from running in the background: tap , and close the apps you don't need.
7. Enable the Background activity manager. The notifications of some apps or emails may not be able to be retrieved instantly. You can manage the battery life by adding or removing the apps to or from the whitelist. Tap **Settings** > **Battery** > **Background activity manager**.
8. Switch on the power saver: tap **Settings** > **Battery** > **Power saver**, and switch to **On**.
9. Use network connections selectively: Switch Bluetooth on only when needed. Use a Wi-Fi connection to connect to the internet, rather than a mobile data connection. Stop your phone scanning for available wireless networks. Tap **Settings** > **Network & Internet** > **Wi-Fi**, and switch to **Off**. If you're listening to music or otherwise using your phone, but don't want to make or receive calls, switch the airplane mode on. Tap **Settings** > **Network & Internet** > **Airplane mode**.

Airplane mode closes connections to the mobile network and switches your device's wireless features off.

SAVE ON DATA ROAMING COSTS

You can cut data roaming costs and save on your phone bills by changing mobile data settings. To use the optimal connection method, change the Wi-Fi and mobile networks settings.

Data roaming means using your phone to receive data over networks that your network service provider doesn't own or operate. Connecting to the internet when roaming, especially when abroad, can raise data costs substantially.

Using a Wi-Fi connection is generally faster and less expensive than using a mobile data connection. If both Wi-Fi and mobile data connections are available, your phone uses the Wi-Fi connection.

Connect to a Wi-Fi network

1. Tap **Settings** > **Network & Internet** > **Wi-Fi**.
2. Make sure Wi-Fi networking is switched to **On**.
3. Select the connection you want to use.

Close the mobile data connection

Swipe down from the top of the screen, tap  **Mobile data** and switch **Mobile data** off.



Tip: To monitor your data usage, tap **Settings** > **Network & Internet** > **Data usage**.

Stop data roaming

Tap **Settings** > **Network & Internet** > **Mobile network**, and switch **Roaming** off.

WRITE TEXT

Learn how to write text quickly and efficiently using your phone's keyboard.

Use the on-screen keyboard

Writing with the on-screen keyboard is easy. You can use the keyboard when holding your phone in portrait or landscape mode. The keyboard layout can vary in different apps and languages.

To open the on-screen keyboard, tap a text box.

Switch between upper and lower case characters

Tap the shift key. To switch caps lock mode on, double-tap the key. To return to normal mode, tap the shift key again.

Enter a number or special character

Tap the numbers and symbols key. Some special character keys bring up more symbols. To see more symbols, tap and hold a symbol or special character.

Insert emojis

Tap the emoji key and select the emoji.

Copy or paste text

Tap and hold a word, drag the markers before and after the word to highlight the section you want to copy and tap **COPY**. To paste the text, tap where you want to paste the text and select **PASTE**.

Add an accent to a character

Tap and hold the character, then tap the accent or the accented character, if supported by your keyboard.

Delete a character

Tap the backspace key.

Move the cursor

To edit a word you just wrote, tap the word and drag the cursor to the place you want.

Use keyboard word suggestions

Your phone suggests words as you write, to help you write quickly and more accurately. Word suggestions may not be available in all languages.

When you start writing a word, your phone suggests possible words. When the word you want is shown in the suggestion bar, select the word. To see more suggestions, tap and hold the suggestion.



Tip: If the suggested word is marked in bold, your phone will automatically use it to replace the word you wrote. If the word is wrong, tap and hold it to see a few other suggestions.

If you do not want the keyboard to suggest words while typing, turn off the text corrections. Tap **Settings** > **System** > **Languages & input** > **Virtual keyboard**. Select the keyboard you normally use. Tap **Text correction** and switch off the text correction methods you do not want to use.

Correct a word

If you notice that you have misspelled a word, tap it to see suggestions for correcting the word.

Switch spell checker off

Tap **Settings** > **System** > **Languages & input** > **Advanced** > **Spell checker**, and switch **Spell checker** to **Off**.

DATE AND TIME

Keep track of time – learn how to use your phone as a clock, as well as an alarm clock, and how to keep your appointments, tasks, and schedules up to date.

Set date and time

Tap **Settings** > **System** > **Date & time**.

Update the time and date automatically

You can set your phone to update the time, date, and time zone automatically. Automatic update is a network service and may not be available depending on your region or service provider.

1. Tap **Settings** > **System** > **Date & time**.
2. Switch **Automatic date & time** on.
3. Switch **Automatic time zone** on.

Change the clock to the 24-hour format

Tap **Settings** > **System** > **Date & time**, and switch **Use 24-hour format** on.

CLOCK AND ALARM

Your clock is not just for alarms – learn what else you can do.

Use the countdown timer

No more overcooking – use the countdown timer to measure your cooking times.

1. Tap **Clock** >  **TIMER**.
2. Set the duration of the timer.



Use the stopwatch

Use the stopwatch to see how you improve on the running track.

Tap **Clock** >  **STOPWATCH**.

Set an alarm

You can use your phone as an alarm clock.

1. Tap **Clock** >  **ALARM**.
2. To add an alarm, tap .
3. To modify an alarm, tap it. To set the alarm to repeat on specific dates, select **Repeat** and highlight the days of the week.

Set an alarm to Snooze

If you don't want to get up just yet, when the alarm sounds, swipe the alarm left. To adjust the snooze length, tap **Clock** >  > **Settings** > **Snooze length** and select the desired length.

Switch an alarm off

When the alarm sounds, swipe the alarm right.

Delete an alarm

Tap **Clock** >  **ALARM**. Select the alarm and tap  **Delete**.

CALCULATOR

Forget your pocket calculator – there's a calculator on your phone.

Use the calculator

Tap **Calculator**.

To use the advanced calculator, swipe the bar from the right edge of the screen to the left.

ACCESSIBILITY

You can change various settings to make using your phone easier.

Increase or decrease the font size

Do you want to have larger fonts on your phone?

1. Tap **Settings** > **Accessibility**.
2. Tap **Font size**. To increase or decrease the font size, drag the Font size slider.

Increase or decrease the display size

Do you want to make the items on your screen smaller or larger?

1. Tap **Settings** > **Accessibility**.
2. Tap **Display size** and adjust the display size by dragging the display size level slider.

NOTES

Make a note

Notes on paper are easy to lose. Instead, jot them down with the Note app. This way, you always have your notes with you.



1. To take a note, tap **Note** > **+**.
2. Write a note.

Your notes are automatically saved.

4 Connect with your friends and family

CALLS

Make a call

1. Tap .
2. Type in a number, or tap **Contacts** and select a contact you want to call.
3. Tap . If you have a second SIM inserted, tap the corresponding icon to make a call from a specific SIM.

Answer a call

When the phone rings, swipe up to answer.



Tip: Don't want to keep your phone in silent mode, but can't answer right now? To silence an incoming call, press the Volume down key. You can also set your phone to mute the ringing when you pick the phone up: tap **Settings** > **System** > **Gestures** > **Mute on pickup**, and switch to on.

If you want to be able to reject an incoming call by turning over the phone, tap **Settings** > **System** > **Gestures** > **Turn over to reject call**, and switch to on.

Reject a call

To reject a call, swipe down.



CONTACTS

Save and organize your friends' and family members' phone numbers.



Save a contact from call history

1. In **Phone**, tap **Dialer** to see call history.
2. Tap the number you want to save.
3. Select if you want to **Add to new contact** or **Add to existed contact**.
4. Type in the contact information, and tap .

Add a contact

1. Tap **Contacts** > .
2. Fill out the information.
3. Tap .

Edit a contact

1. Tap **Contacts** and tap the contact you want to edit.
2. Tap .
3. Edit the information.
4. Tap .

Search for a contact

1. Tap **Contacts**.
2. Tap .

Filter your contacts list

Tap **Contacts** >  > **Settings** > **Contacts to display**.



Import or export contacts

Tap **Contacts** >  > **Settings** > **Import contacts/export contacts**.

SEND AND RECEIVE MESSAGES

Keep in touch with your friends and family members through text messages.

Send a message

1. Tap **Messages**.
2. Tap .
3. To add a recipient, type their number in the recipient's box. To add a contact, start typing their name and tap the contact.
4. After choosing all of the recipients, tap .
5. Write your message in the text box.
6. Tap .



Tip: If you want to send a photo in a message, tap **Gallery**, tap the photo you want to share and tap . Select **Messages**.

Read a message

1. Tap **Messages**.
2. Tap the message you want to read. You can also read a message from the notification panel. Slide down from the top of the screen and tap the message.

Reply to a message

1. Tap **Messages**.
2. Tap the message you want to reply to.
3. Write your reply in the text box below the message and tap .

GET SOCIAL

Want to connect and share stuff with the people in your life? With social apps, you can stay up to date with what's happening with your friends.

Social apps

To keep in touch with your friends and family, sign in to your instant messaging, sharing, and social networking services. Select the service you want to use from your home screen. Social apps are available in the App Market. The available services may vary.

5 Camera

CAMERA BASICS

Why carry a separate camera when your phone has all you need for capturing memories? With your phone's camera, you can easily take photos or record videos.



Take a photo

Shoot sharp, vibrant photos – capture the best moments in your photo album.

1. Tap **Camera**.
2. Take aim and focus.
3. Tap .





Take a selfie

Need that perfect selfie? Use the phone's front camera to take one.

1. Tap **Camera**.
2. Tap  to switch to the front camera.
3. Take aim and focus.
4. Tap .

Take a bothie

In addition to the perfect selfie, you can take a split-screen photo with your phone's cameras. Use the front and rear cameras simultaneously.

1. Tap **Camera** and tap .
2. Tap  **Dual** for a split-screen photo. Or to take a picture-in-picture photo, tap .
3. Take aim and focus.
4. Tap .
5. To go back to Full screen mode, **single** tap .



Tip: When you take a picture-in-picture photo or record a picture-in-picture video, and want to move the smaller picture, tap and hold it and drag it to where you want it.

Take panoramas

Tap **Camera** > ≡ > 🖼️ **Panorama** and follow the instructions on your phone.

RECORD A VIDEO

Use the full 360° surround system

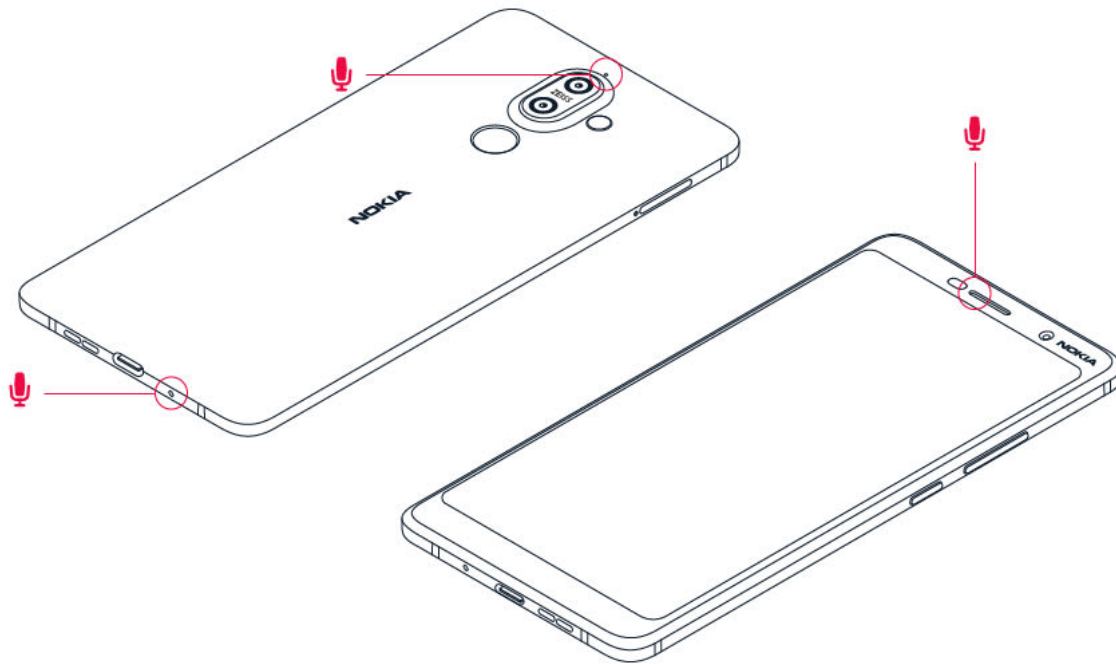



With your phone camera, you can easily record videos with a full 360° surround sound. Tap **Camera**. To switch to the video recording mode, swipe to left.

Your phone has three microphones that are used by OZO Audio technology to record and process audio spatially. In the video recording mode, to change the way audio is recorded, tap 🎧.

1. To clearly record what is in front of you, while silencing audio coming from behind, tap 🎧 **Front**. Use this setting when you, for example, interview someone.
2. To clearly record your own voice or audio coming from behind you, while silencing audio coming in front, tap 🎧 **Rear**.
3. To record audio naturally from all directions, tap 🎧 **Surround**.





To optimize the audio quality for your videos, do not cover any of the small microphone holes of your phone while recording a video. To record the a full 360° degrees surround sound, keep the phone in a horizontal position, and hold it by the long edges.

Record a video

1. Tap **Camera**.
2. To switch to Video recording mode, swipe to the left.
3. Tap  **Video** to start recording.
4. To stop recording, tap .
5. To go back to Camera mode, swipe to the right.



Record a bothie video

You can record a split-screen video with your phone. Use the front and rear cameras simultaneously.

1. Tap **Camera**.
2. To switch to Video recording mode, swipe to the left. Tap .
3. Tap  **Dual** for a split-screen video. Or to record a picture-in-picture video, tap  **P-I-P**.
4. Tap  to start recording.

Stream live video



With your phone's camera, you can stream live video for social apps.

1. Tap **Camera**. To switch to the video recording mode, swipe to the left.
2. Tap  and select the social media account you want to use for the live broadcast.
3. Tap  to start live streaming.

USE YOUR CAMERA LIKE A PRO

Use the different modes on your camera to enhance the quality of your photos.

Learn about your camera's settings



In the Camera app, tap  >  **Settings** to learn more about each setting.

Use the camera in Manual mode

With Manual mode, you can take close-ups, wide angle photos, change your camera's ISO settings, and adjust the AWB (Auto White Balance). To try out Manual mode, tap **Camera** >  **Pro**.



Use Live Bokeh mode

If you want to be able to change the focus area of your photo after you have taken it, use the Live Bokeh mode when taking a photo.





1. Tap **Camera**.
2. Tap  > **Live Bokeh**.
3. Take aim and focus. Tap  **Live Bokeh**.
4. Tap the photo you just took on the bottom right corner of the display.
5. Tap **Bokeh Editor** to edit your photo.

Take photos with a timer



Want to have time to get in the shot too? Try out the timer.

1. Tap **Camera**.
2. Tap . The button shows the timer setting. To change it, tap it again.
3. Select the duration of the timer.
4. Tap  **Photo**.

Record a slow motion video

1. To switch to Video recording mode, swipe to the left.
2. Tap .
3. Tap  **Slow Motion**.
4. Tap  **Slow Motion** to start recording.
5. To stop recording, tap .

Take high quality photos

In the Camera app, tap  >  **Settings** > **Resolution** and set the resolution that you want to use.



SAVE YOUR PHOTOS AND VIDEOS TO A MEMORY CARD

If there is a memory card in your phone and your phone memory is filling up, save the photos you take and videos you record to the memory card.



Tip: For the best video quality, record videos to your phone memory. If you record videos to the memory card, it is recommended that the microSD card you use is a fast 4-128 GB card from a well-known manufacturer.

Change the location of saved photos and videos

1. Tap **Camera**.
2. Tap  >  **Settings** > **Data storage**.

YOUR PHOTOS AND VIDEOS

View photos and videos on your phone

Want to relive those important moments? View the photos and videos on your phone.

Tap **Gallery**.

Copy your photos and videos to your computer

Do you want to view your photos or videos on a larger screen? Move them to your computer.

You can use your computer's file manager to copy or move your photos and videos to the computer.

Connect your phone to the computer with a compatible USB cable. To set the USB connection type, open the notification panel and tap the USB notification.

Share your photos and videos

You can share your photos and videos quickly and easily for your friends and family to see.

1. In **Gallery**, tap the photo you want to share.
2. Tap .
3. Select how you want to share the photo or video.

6 Internet and connections

ACTIVATE WI-FI

Using a Wi-Fi connection is generally faster and less expensive than using a mobile data connection. If both Wi-Fi and mobile data connections are available, your phone uses the Wi-Fi connection.

Turn on Wi-Fi

1. Tap **Settings** > **Network & Internet** > **Wi-Fi**.
2. Switch **Wi-Fi** to **On**.
3. Select the connection you want to use.

Your Wi-Fi connection is active when  is shown on the status bar at the top of the screen.

Important: Use encryption to increase the security of your Wi-Fi connection. Using encryption reduces the risk of others accessing your data.

USE A MOBILE DATA CONNECTION

Close the mobile data connection

Swipe down from the top of the screen, tap  **Mobile data** and switch **Mobile data** off.

Turn on the mobile data connection

Swipe down from the top of the screen, tap **Mobile data** and switch **Mobile data** on.

Use a mobile data connection when roaming

Tap **Settings** > **Network & Internet** > **Mobile network**, and switch **Data roaming** to **On**.¹



Tip: To monitor your data usage, tap **Settings** > **Network & Internet** > **Data usage**.¹

Connecting to the internet when roaming, especially when abroad, can raise data costs substantially.

BROWSE THE WEB

Use your phone to connect your computer to the internet

It's simple to use the internet on your laptop on the go. Turn your phone into a Wi-Fi hotspot and use your mobile data connection to access the internet with your laptop or other device.

1. Tap **Settings** > **Network & Internet** > **Hotspot & tethering**.
2. Switch on the **Wi-Fi hotspot** to share your mobile data connection over Wi-Fi, **USB tethering** to use a USB connection, or **Bluetooth tethering** to use Bluetooth.

The other device uses data from your data plan, which may result in data traffic costs. For information on availability and costs, contact your network service provider.

Start browsing

No need for a computer – you can easily browse the internet on your phone. Catch up on the news, and visit your favorite websites. You can use the browser on your phone to view web pages on the internet.

1. Tap browser.
2. Type a web address and tap **enter**.



Tip: If your network service provider doesn't charge you a fixed fee for data transfer, to save on data costs, use a Wi-Fi network to connect to the internet.

Open a new tab

When you want to visit several websites at the same time, you can open new browser tabs and switch between them.

In browser,

1. Tap the box next to the toolbar.
2. Tap **+**.

Switch between tabs

In browser,

1. Tap the box next to the toolbar.
2. Tap the tab you want.

Close a tab

In browser,

1. Tap the box next to the toolbar.
2. Tap **X** on the tab you want to close.

Search the web

Explore the web and the outside world with search. You can use the keyboard to write your search words.

In browser,

1. Tap the search bar.
2. Write your search word in the search box.
3. Tap **Search for**.

You can also select a search word from the proposed matches.

Use your data plan efficiently

If you're worried about your data usage costs, your phone helps you prevent some apps from sending or receiving data when running in the background.

1. Tap **Settings** > **Network & Internet** > **Data usage** > **Data saver**.
2. Switch **Data saver** to **On**.

CLOSE A CONNECTION

Close internet connections

Save your battery by closing internet connections that are open in the background. You can do it without closing any apps.

1. Tap **Settings** > **Network & Internet** > **Wi-Fi**.
2. Switch **Wi-Fi** to **Off**.

Close the mobile data connection

Swipe down from the top of the screen, tap  **Mobile data** and switch **Mobile data** off.

Switch on Flight mode

1. Tap **Settings** > **Network & Internet**.
2. Switch on **Flight mode**.

Flight mode closes connections to the mobile network and turns your device's wireless features off. Comply with the instructions and safety requirements given by, for example, an airline, and any applicable laws and regulations. Where allowed, you can connect to a Wi-Fi network to, for example, browse the internet or switch Bluetooth sharing on in aeroplane mode.

BLUETOOTH®

You can connect wirelessly to other compatible devices, such as phones, computers, headsets, and car kits. You can also send your photos to compatible phones or to your computer.

Connect to a Bluetooth accessory

You can connect your phone with many useful Bluetooth devices. For example, with a wireless headset (sold separately), you can speak on the phone hands-free – you can continue what you're doing, such as working at your computer, during a call. Connecting a phone to a Bluetooth device is called pairing.

1. Tap **Settings** > **Connected devices** > **Bluetooth**.
2. Switch **Bluetooth** to **On**.
3. Make sure the other device is switched on. You may need to start the pairing process from the other device. For details, see the user guide for the other device.
4. To pair your phone and the device, tap the device in the list of discovered Bluetooth devices.
5. You may need to enter a passcode. For details, see the user guide for the other device.

Since devices with Bluetooth wireless technology communicate using radio waves, they do not need to be in direct line-of-sight. Bluetooth devices must, however, be within 10 metres (33 feet) of each other, although the connection may be subject to interference from obstructions such as walls or from other electronic devices.

Paired devices can connect to your phone when Bluetooth is switched on. Other devices can detect your phone only if the Bluetooth settings view is open.

Do not pair with or accept connection requests from unknown devices. This helps to protect your phone from harmful content.

Remove a pairing

If you no longer have the device that you paired your phone with, you can remove the pairing.

1. Tap **Settings** > **Connected devices** > **Bluetooth**.
2. Tap  next to a device name.
3. Tap **FORGET**.

Connect to your friend's phone with Bluetooth

You can use Bluetooth to wirelessly connect to your friend's phone, to share photos, and much more.

1. Tap **Settings** > **Connected devices** > **Bluetooth**.
2. Make sure Bluetooth is switched on on both phones.
3. Make sure the phones are visible to each other. You need to be in the Bluetooth settings view for your phone to be visible to other phones.
4. You can see the Bluetooth phones within range. Tap the phone you want to connect to.
5. If the other phone needs a passcode, enter or accept the passcode, and tap **Pair**.

The passcode is only used when you connect to something for the first time.

Send your content using Bluetooth

When you want to share your content or send photos you've taken to a friend, use Bluetooth to send them to compatible devices.

You can use more than one Bluetooth connection at a time. For example, while using a Bluetooth headset, you can still send things to another device.

1. Tap **Settings** > **Connected devices** > **Bluetooth**.
2. Switch **Bluetooth** to **On**.
3. Go to the content you want to send and tap  > **Bluetooth**.
4. Tap the device to connect to. You can see the Bluetooth devices within range.
5. If the other device needs a passcode, enter the passcode. The passcode, which you can make up, must be entered on both devices. The passcode in some devices is fixed. For details, see the user guide for the other device.

The location of the received files depends on the other device. For details, see the user guide for the other device.

NFC

Explore the world around you. If your phone supports Near Field Communication (NFC), you can tap accessories to connect to them, and tap tags to call someone or go to a website.

Get started with NFC

Switch on the NFC features in your phone and start tapping to share stuff or connect to devices. To see if your phone supports NFC, tap **Settings** > **Connected devices**.

With NFC, you can:

- Connect to compatible Bluetooth accessories that support NFC, such as a headset or a wireless loudspeaker
- Tap tags to get more content for your phone or to access online services
- Pay with your phone, if supported by your network service provider

The NFC area is on the back of your phone. Tap other phones, accessories, tags, or readers with the NFC area.

1. Tap **Settings** > **Connected devices** > **NFC**.
2. Switch **NFC** to **On**.

Before using NFC, make sure the screen and keys are unlocked.

Read NFC tags

NFC tags can contain information, such as a web address, a phone number, or a business card. The information you want is just a tap away.

To read a tag, tap the tag with the NFC area of your phone.



Note: Payment and ticketing apps and services are provided by third parties. HMD Global does not provide any warranty or take any responsibility for any such apps or services including support, functionality, transactions, or loss of any monetary value. You may need to reinstall and activate the cards you have added as well as the payment or ticketing app after repair of your device.

Connect to a Bluetooth accessory with NFC

Hands busy? Use a headset. Or why not listen to music using wireless speakers? You only need to tap the compatible accessory with your phone.

1. Tap the NFC area of the accessory with the NFC area of your phone.*
2. Follow the instructions on the screen.

*Accessories are sold separately. The availability of accessories varies by region.

Disconnect the connected accessory

If you don't need to be connected to the accessory anymore, you can disconnect the accessory.

Tap the NFC area of the accessory again.

For more information, see the accessory's user guide.

VPN

You may need a Virtual Private Network (VPN) connection to access your company resources, such as intranet or corporate mail, or you may use a VPN service for personal purposes.

Contact your company IT administrator for details of your VPN configuration or check your VPN service's website for additional information.

Use a secure VPN connection

1. Tap **Settings** > **Network & Internet** > **VPN**.
2. To add a VPN profile, tap **+**.
3. Enter the profile information as instructed by your company IT administrator or VPN service.

Edit a VPN profile

1. Tap **⚙️** next to a profile name.
2. Change the info as required.

Delete a VPN profile

1. Tap **⚙️** next to a profile name.
2. Tap **FORGET VPN**.

7 Apps and services

APPSTORE AND PRELOADED APPS

Your Android phone can live up to its full potential with app store.

Download apps



Application examples¹

Unleash your phone's potential – there are thousands of apps waiting in the AppStore to help you with this.

1. Tap **AppStore**.
2. Tap the search bar to look for apps, or select apps from your recommendations.
3. In the app description, tap **INSTALL** to download and install the app.

Installed apps are available in the Apps menu. To see your apps, go to the home screen and swipe left.

System applications:

App store: Download and upgrade apps
Browser: Browse internet
clock: Provide time information and other clock functions
calendar: Display dates and provide task management
File management: Browse and manage files
Call: Make calls and manage contacts
Contact: Store and manage contacts
Text: Send and receive text
Camera: Take pictures and videos
FM Radio: Listen to FM radio stations
Gallery: Browse and edit pictures
Smart tuner: Device security protection and operational enhancement features

System applications provide basic functions, including but not limiting to all HMD proprietary or Android native applications. (such as google pinyin input method). To ensure device works as design, these apps are not able to be removed.

Native applications:

Memo: Record reminders, notes and tasks Recorder: Record audio memos Calculator: Basic and scientific calculator functions Weather: Real time weather forecast and information Music: Play music

Native applications provide common functions, user can long press the app icon and drag it to the “uninstall” area in upper-right area of the screen.

3rd party applications:

Alipay: Payment, money transfer and shopping; Alipay Wechat: Real time communication and social networking tool; Tencent Weibo: Social networking applications; Sina

¹ Above snapshots were used to provide application examples, final view from your device maybe slightly different.

8 Software updates and backups

UPDATE YOUR PHONE SOFTWARE

Stay in step with the beat – update your phone software and apps wirelessly to get new and enhanced features for your phone. Updating the software may also improve your phone performance.

Install available updates

Tap **Settings** > **System** > **System updates** > **Update** to check if updates are available.

When your phone notifies you that an update is available, just follow the instructions shown on your phone. If your phone is low on memory, you may need to move your apps, photos, and other stuff to the memory card. ¹

Warning: If you install a software update, you cannot use the device, even to make emergency calls, until the installation is completed and the device is restarted.

Before starting the update, connect a charger or make sure the device battery has enough power, and connect to Wi-Fi, as the update packages may use up a lot of mobile data.

¹ The memory card is sold separately.

BACK UP YOUR DATA

To ensure your data is safe, use the backup feature in your phone. Your device data (such as Wi-Fi passwords and call history) and app data (such as settings and files stored by apps) will be backed up remotely.

Switch on automatic backup

Tap **Settings** > **System** > **Backup**, and switch backup on.

RESTORE ORIGINAL SETTINGS AND REMOVE PRIVATE CONTENT FROM YOUR PHONE

Accidents can happen – if your phone is not working properly, you can restore its settings. Or, if you buy a new phone, or otherwise want to dispose of or recycle your phone, here's how you can remove your personal info and content. Note that it is your responsibility to remove all private content.

Reset your phone

1. Tap **Settings** > **System** > **Reset options** > **Erase all data (factory reset)**.
2. Follow the instructions shown on your phone.

STORAGE

To check how much memory you have available, tap **Settings** > **Storage**.

Disable an app

You can't delete some apps that were pre-installed on your device. But you can disable them and they will be hidden from the list of apps on your device. If you disable an app, you can add it back to your device.

1. Tap **Settings** > **Apps & notifications**.
2. Tap **App info**.
3. Tap the app name.
4. Tap **DISABLE**. You may not be able to disable all apps.

If an installed app depends on a removed app, the installed app may stop working. For details, see the user documentation of the installed app.

Re-add a disabled app

You can add a disabled app back onto the list of apps.

1. Tap **Settings** > **Apps & notifications**.
2. Tap **App info**.
3. Tap **All apps** > **Disabled apps**.
4. Tap the app name.
5. Tap **ENABLE**.

Copy content between your phone and computer

You can copy photos, videos, and other content created by you between your phone and computer to show or store them.

1. Connect your phone to a compatible computer with a compatible USB cable.
2. On your computer, open a file manager, and browse to your phone.
3. Drag and drop items from your phone to the computer or from your computer to the phone.

Make sure you put the files in the right folders on your phone or you may not be able to see them.

9 Protect your phone

PROTECT YOUR PHONE WITH YOUR FINGERPRINT

You can unlock your phone with just a touch of your finger. Set up your fingerprint ID for extra security.

Add a fingerprint

1. Tap **Settings** > **Security & Location** > **Fingerprint** . If you don't have screen lock set up on your phone, tap **Screen lock** .
2. Select which backup unlocking method you want to use for the lock screen and follow the instructions shown on your phone.

Unlock your phone with your finger

Place your registered finger on the sensor.

If there is a fingerprint sensor error, and you cannot use alternative sign-in methods to recover or reset the phone in any way, your phone will require service by authorised personnel. Additional charges may apply and all the personal data on your phone may be deleted. For more information, contact the nearest care point for your phone or your phone dealer.

CHANGE YOUR SIM PIN

If your SIM card came with a default SIM PIN, you can change it to something more secure. Not all network service providers support this.

Select your SIM PIN

You can choose which digits to use for the SIM PIN. The SIM PIN can be 4-8 digits.

1. Tap **Settings** > **Security & Location** > **SIM card lock** .
2. Under the selected SIM card, tap **Change SIM PIN** .



Tip: If you don't want to protect your SIM with a PIN, switch **Lock SIM card** to **Off** , and type in your current PIN.

ACCESS CODES

Learn what the different codes on your phone are for.

PIN or PIN2

PINs or PIN2s have 4-8 digits.

These codes protect your SIM card against unauthorised use or are required to access some features. You can set your phone to ask for the PIN when you switch it on.

If you forget the codes or they aren't supplied with your card, contact your network service provider.

If you enter the code incorrectly 3 times in a row, you'll need to unblock the code with the PUK or PUK2 code.

PUK or PUK2 codes

PUK or PUK2 codes are required to unblock a PIN or PIN2.

If the codes are not supplied with your SIM card, contact your network service provider.

Lock code

Lock code is also known as security code or password.

The lock code helps you protect your phone against unauthorised use. You can set your phone to ask for the lock code that you define. Keep the code secret and in a safe place, separate from your phone.

If you forget the code and your phone is locked, your phone will require service. Additional charges may apply and all the personal data on your phone may be deleted. For more info, contact the nearest authorised service facility for your phone, or your phone dealer.

IMEI code

The IMEI code is used to identify phones in the network. You may also need to give the number to your authorised service facility services or phone dealer.

To view your IMEI number, dial `*#06#`.

Your phone's IMEI code is also printed either on your phone or on the SIM tray depending on your phone model. If your phone has a removable back cover, you can find the IMEI code under the cover.

The IMEI is also visible on the original sales box.

10 Product and safety information

COPYRIGHTS AND NOTICES

Copyrights and other notices

The availability of products, features, apps, and services may vary by region. For more information, contact your dealer or your service provider. This device may contain commodities, technology, or software subject to export laws and regulations from the US and other countries. Diversion contrary to law is prohibited.

The contents of this document are provided "as is". Except as required by applicable law, no warranties of any kind, either express or implied, including, but not limited to, the implied warranties of merchantability and fitness for a particular purpose, are made in relation to the accuracy, reliability, or contents of this document. HMD Global reserves the right to revise this document or withdraw it at any time without prior notice.

To the maximum extent permitted by applicable law, under no circumstances shall HMD Global or any of its licensors be responsible for any loss of data or income or any special, incidental, consequential, or indirect damages howsoever caused.

Reproduction, transfer, or distribution of part or all of the contents in this document in any form without the prior written permission of HMD Global is prohibited. HMD Global operates a policy of continuous development. HMD Global reserves the right to make changes and improvements to any of the products described in this document without prior notice.

HMD Global does not make any representations, provide a warranty, or take any responsibility for the functionality, content, or end-user support of third-party apps provided with your device. By using an app, you acknowledge that the app is provided as is.

Downloading of maps, games, music, and videos and uploading of images and videos may involve transferring large amounts of data. Your service provider may charge for the data transmission. The availability of particular products, services, and features may vary by region. Please check with your local dealer for further details and availability of language options.

Certain features, functionality, and product specifications may be network dependent and subject to additional terms, conditions, and charges.

All are subject to change without notice.

HMD Global Oy is the exclusive licensee of the Nokia brand for phones and tablets. Nokia is a registered trademark of Nokia Corporation.

HMD Global Privacy Policy, available at <http://www.hmd.com/privacy>, applies to your use of the device.

Qualcomm and Snapdragon are trademarks of Qualcomm Incorporated, registered in the United States and other countries.

Android, Google, and Google Play are trademarks of Google Inc.

All other trademarks are the property of their respective owners.