

NOKIA

Nokia 3310 4G

User Guide

Table of Contents

1	About this user guide	5
2	Get started	6
	Keys and parts	6
	Set up and switch on your phone	7
	Charge your phone	9
3	Basics	11
	Explore your phone	11
	Change the volume	14
	Write text	14
4	Calls, contacts, and messages	15
	Calls	15
	Contacts	15
	Send and receive messages	16
5	Personalize your phone	17
	Change the tones	17
	Change the look of your home screen	17
6	Camera	18
	Photos	18
	Videos	18
7	Internet and connections	19
	Browse the web	19
	Bluetooth®	19
	WLAN	19

8 Music, audio and videos	21
Music player	21
Voice recorder	21
Video player	21
9 Radio	22
Find and save radio stations	22
Listen to radio	22
10 Clock, calendar, and calculator	23
Set the time and date manually	23
Clock	23
Calendar	24
Calculator	24
11 Update the phone software	25
Software updates	25
12 Copy content and check the memory	26
Copy content	26
Uninstall apps	26
Memory	26
13 Tools	27
Notification center	27
File explorer	27
Torch	27
Notes	27
14 Settings	28
Change the settings	28

15 Product and safety information	30
For your safety	30
Network services and costs	32
Emergency calls	32
Take care of your device	33
Recycle	34
Crossed-out wheellie bin symbol	34
Battery and charger information	35
Small children	35
Medical devices	36
Implanted medical devices	36
Hearing	36
Protect your device from harmful content	36
Vehicles	37
Potentially explosive environments	37
About Digital Rights Management	37
Copyrights and other notices	37

1 About this user guide



Important: For important information on the safe use of your device and battery, read “Product and safety information” before you take the device into use. To find out how to get started with your new device, read the user guide.

2 Get started

KEYS AND PARTS

Explore the keys and parts of your new phone.

Your phone

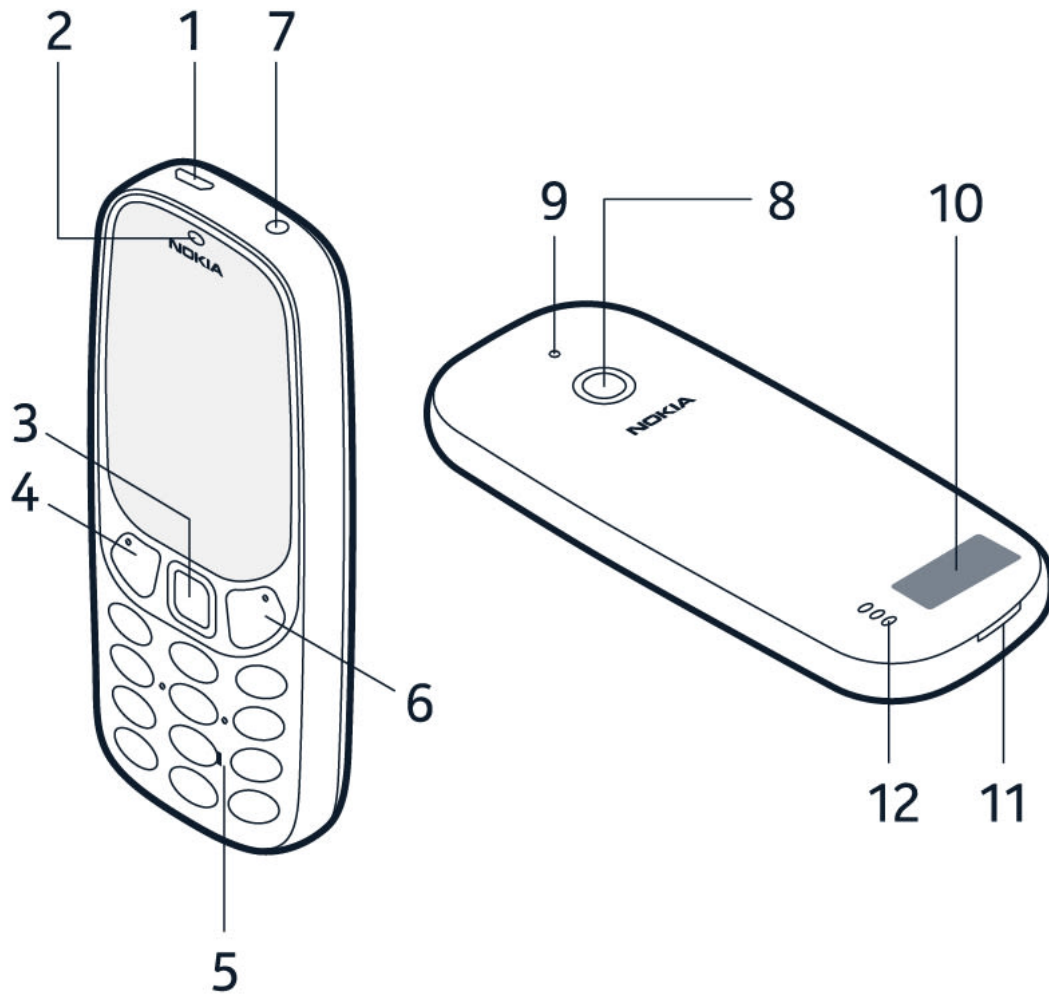

The keys and parts of your phone are:

- | | |
|----------------------------------------------|------------------------------------------|
| 1. Charger connector | 6. Function key, end call key, power key |
| 2. Earpiece | 7. Headphone connector |
| 3. Scroll key | 8. Camera |
| 4. Function key, call key, speed dialing key | 9. Flash light |
| 5. Number keys | 10. Antenna area |

11. Back cover opening slot

12. Loudspeaker

To unlock the keys, select **Unlock** > *.

Avoid touching the antenna area while the antenna is in use. Contact with antennas affects the communication quality and may reduce battery life due to higher power level during operation.

Do not connect to products that create an output signal, as this may damage the device. Do not connect any voltage source to the audio connector. If you connect an external device or headset, other than those approved for use with this device, to the audio connector, pay special attention to volume levels. Parts of the device are magnetic. Metallic materials may be attracted to the device. Do not place credit cards or other magnetic storage media near the device, because info stored on them may be erased.

Some of the accessories mentioned in this user guide, such as charger, headset, or data cable, may be sold separately.

SET UP AND SWITCH ON YOUR PHONE

Learn how to insert the SIM card, memory card, and battery, and how to switch on your phone.

Micro SIM



Important: This device is designed to be used with a micro SIM card (see figure) only. Use of incompatible SIM cards may damage the card or the device, and may corrupt data stored on the card. Please consult your mobile operator for the use of a SIM card that has a nano-UICC cutout.

MicroSD memory cards



Use only compatible memory cards approved for use with this device. Incompatible cards may damage the card and the device and corrupt data stored on the card.

- ⚠ **Note:** Switch the device off and disconnect the charger and any other device before removing any covers. Avoid touching electronic components while changing any covers. Always store and use the device with any covers attached.

Set up your phone

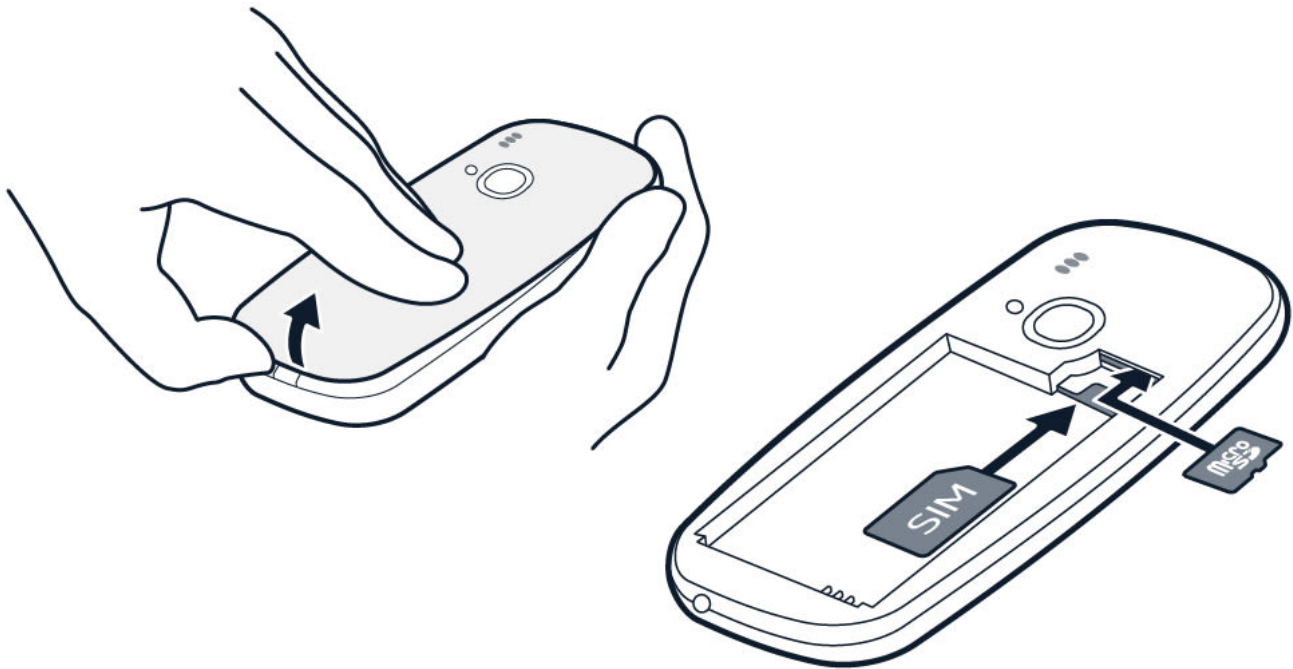

1. Place your fingernail in the small slot at the bottom of the phone, lift and remove the cover.
2. If the battery is in the phone, lift it out.
3. Slide the SIM into the SIM slot with the contact area face down.
4. If you have a memory card, slide the memory card into the memory card slot.
5. Line up the battery contacts, and put the battery in.
6. Replace the back cover.

Switch on your phone

Press and hold the  key.

Remove the SIM card

Open the back cover, remove the battery, and slide the SIM out.

Remove the memory card

Open the back cover, remove the battery, and pull the memory card out.

Access codes

Your phone and SIM card use different codes for security.

- PIN or PIN2 codes: These codes protect your SIM card against unauthorized use. If you forget the codes or they aren't supplied with your card, contact your network service provider. If you type in the code incorrectly 3 times in a row, you need to unblock the code with the PUK or PUK2 code.
- PUK or PUK2 codes: These codes are required to unblock a PIN or PIN2 code. If the codes are not supplied with your SIM card, contact your network service provider.
- IMEI code: The IMEI code is used to identify phones in the network. You may also need to give the number to your care point services or phone dealer. To view your IMEI number, dial ***#06#**. Your phone's IMEI code is also printed on your phone label, which is located under the battery. The IMEI is also visible on the original sales box.

CHARGE YOUR PHONE

Your battery has been partially charged at the factory, but you may need to recharge it before you can use your phone.

Charge the battery

1. Plug the charger into a wall outlet.
2. Connect the charger to the phone. When done, unplug the charger from the phone, then from the wall outlet.

If the battery is completely discharged, it may take several minutes before the charging indicator is displayed.



Tip: You can use USB charging when a wall outlet is not available. Data can be transferred while charging the device. The efficiency of USB charging power varies significantly, and it may take a long time for charging to start and the device to start functioning. Make sure your computer is switched on.

Save power

To save power:

1. Charge wisely: always charge the battery fully.
2. Select only the sounds that you need: mute unnecessary sounds, such as keypad sounds.
3. Use a wired headset, rather than the loudspeaker.
4. Change the phone screen settings: set the phone screen to switch off after a short time.
5. Lower the screen brightness.
6. When applicable, use network connections, such as Bluetooth, selectively: switch the connections on only when you are using them.
7. Turn off Wi-Fi hotspot when internet sharing is not needed.

3 Basics

EXPLORE YOUR PHONE

See the apps and features of your phone



Select **Menu**.

Go to an app or feature

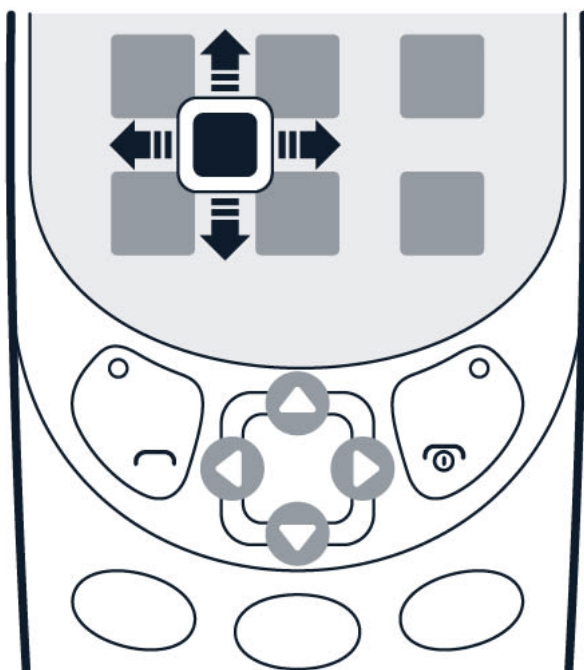

Press the scroll key up, down, left, or right.

Open an app or select a feature



Select **Select**.

Go back to the previous view

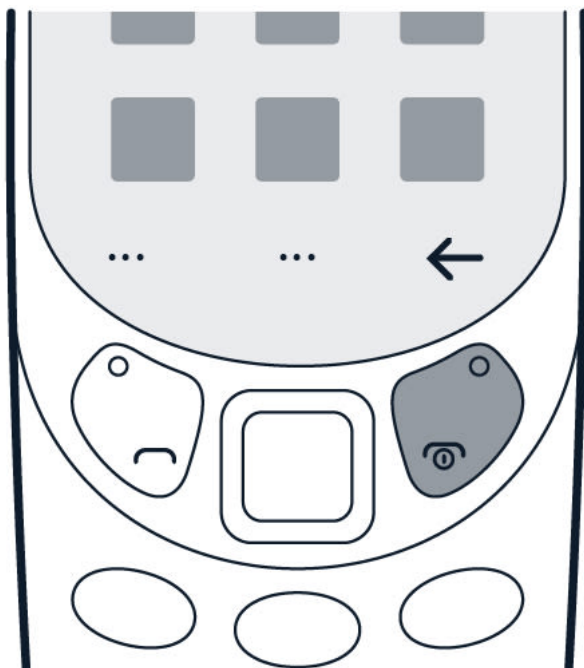

Press ←.

Go back to the home screen

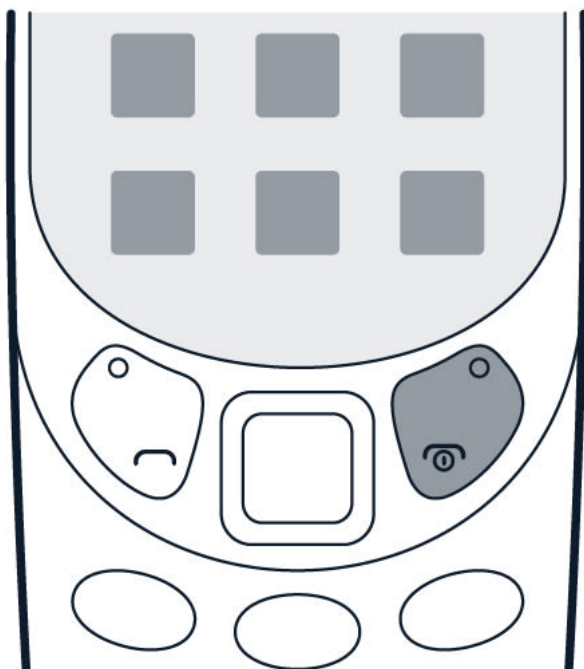

Press the end key.

CHANGE THE VOLUME

Turn the volume up or down

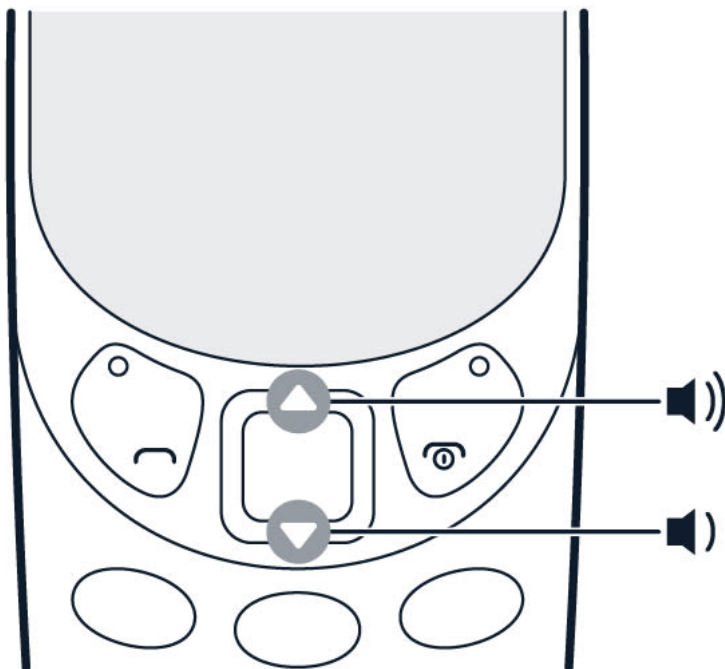

Trouble hearing your phone ringing in noisy environments, or calls too loud? You can change the volume to your liking.

Scroll up or down to change the volume during a call or when listening to the radio. In some applications, you need to press the * and # keys to control the volume.

WRITE TEXT

Writing with the keypad is easy and fun.

Write using the keypad

Press a key repeatedly until the letter is shown.

To type in a space, press **0**.

To type in a special character or punctuation mark, press *****.

To switch between character cases, press **#** repeatedly.

To type in a number, press and hold a number key.



The writing method may vary between applications.

4 Calls, contacts, and messages

CALLS

Make a call

Learn how to make a call with your new phone.

1. Type in the phone number.
2. Press .
3. To end the call, press .

Answer a call

Press .



Tip: To handle your calls hands-free, pair your phone with a compatible Bluetooth headset (sold separately). To switch Bluetooth on, select **Menu** >  > **Bluetooth** > **Select**.

Speed dial

You can call a contact quickly using speed dial.



1. To assign a speed dial to each number key on your phone, select .
2. Scroll to the number key you want to use and select it.
3. Select the phone number from the list.

To make a call using the speed dial, select  and the contact.

CONTACTS

Add a contact

Save and organize your friends' phone numbers.

1. Select **Menu** >  >  > **Add Contact**.
2. Select whether to save the contact to the phone memory or the SIM card.

3. Write the name and phone number of the contact. You can add several phone numbers to the contact.
4. Select .





Tip: To bar any calls from a contact, select the contact and  > **Add to blacklist**.

Copy contacts

Copy contacts between your SIM card and the phone.



To copy contacts between your phone and SIM card, in the contacts list, select  > **Import/Export** > **Copy to** > **Phone** or **SIM Card**.

You can also import contacts from your phone memory or a memory card. Select  > **Import/Export** > **Import from internal storage** or **Import from external storage**.

To share a contact with a friend, select  > **Import/Export** > **Share visible contacts**, then select the contact and  > **Done**. Select to share the contact using either Bluetooth or Messaging.



Call a contact or send a message

You can call a contact directly from the contacts list.

1. Select **Menu** >  and scroll to a contact.
2. Select the contact and press .

SEND AND RECEIVE MESSAGES

Write and send messages

1. Select **Menu** >  > **New**.
2. Add the recipients. You can enter a phone number directly or select  to add a recipient from your contacts.
3. Write the message.
4. Select **Send**.

Writing options

You can find different options for writing a message from  when you are in the message field. You can attach or take a picture, record a video, or add a contact card. If you are in a hurry, you can quickly select from a list of common phrases to explain your situation.



5 Personalize your phone

CHANGE THE TONES

You can choose a new ringtone or notification tone.

Change your ring and notification tone



Select **Menu** >  > **Audio profiles**. You can select a pre-defined audio profile, or create your own.

1. To create your own, select  > **Add**. select the ring tone and notification tones.
2. Write a name for the profile and select **OK**.
3. Select the profile and **Edit**. You can now
4. To save the profile, select .
5. To switch on the profile, select the profile and **Use**.

CHANGE THE LOOK OF YOUR HOME SCREEN

You can change the look of your phone with wallpapers.

Choose a new wallpaper

1. Select **Menu** >  > **Display** > **Wallpaper**, and select **Gallery** to choose a wallpaper from the photos on your phone or **Wallpapers** to choose a wallpaper from the collection.
2. Scroll to a wallpaper and select it to see how it looks on the screen.
3. Select .

6 Camera

PHOTOS



You don't need a separate camera when your phone has all you need for capturing memories.

Take a photo

Capture the best moments with your phone camera.

1. To switch the camera on, select **Menu** > .
2. To take a photo, press the scroll key.

View a photo you have taken



To view the photo right after taking it, select  > **Gallery**. To view the photo later, select **Menu** > .

VIDEOS



You don't need a separate video camera - record video memories with your phone.

Record a video

Besides taking photos, you can also record videos with your phone.

1. To switch the video camera on, select **Menu** > , and select .
2. To start recording, press the scroll key.
3. To stop recording, select .

Watch the recorded video

To view the video right after recording, select  > **Gallery**. To view the video later, select **Menu** > .

7 Internet and connections

BROWSE THE WEB

Learn how to browse the web with your phone.

Connect to internet

Catch up on the news, and visit your favorite websites on the go.

1. Select **Menu** > .
2. Write a web address, and select **Go**.
3. Use the scroll key to move the mouse cursor in the browser.

The browser is the UC Browser of the Alibaba Group. You may not be able to access some websites due to limitations in the browser and the phone memory.



Tip: There are two cursor modes available. In the arrow mode, you can move around web pages and click on items. In the mouse scroll mode, you can move up and down on web pages. To switch between the modes, press the left selection key.

BLUETOOTH®

Connect your phone with Bluetooth to other devices.

Switch on Bluetooth

Select **Menu** >  > **Bluetooth** and switch **Bluetooth** on.

WLAN

Start a wireless LAN connection.

Switch on WLAN

1. Select **Menu** >  > **Wi-Fi**.
2. Press the scroll key to look for available networks.
3. Select the network you want, enter a password if needed, and select **Connect**.

Use your phone as a WLAN hotspot

Need a network connection on your laptop? You can use your phone as a WLAN hotspot.

1. Select **Menu** >  > **Portable Wi-Fi hotspot**, and switch the hotspot on.
2. Select **Set up Wi-Fi hotspot**.
3. Enter the details and select **Save**.

You can now, for example, switch WLAN on in your laptop and connect it to the phone's WLAN hotspot.

8 Music, audio and videos

MUSIC PLAYER

You can listen to your MP3 music files with the music player.

Listen to music

1. Select **Menu** > .
2. Select whether you want to view your songs, artists, albums, or playlists.
3. Scroll to a song, and select **Play**.





Tip: Use the phone keys to control the music player. To move to the previous song, press **4**. To pause and resume the music, press **5**. To move to the next song, press **6**. To turn down the volume, press *****. To turn up the volume, press **#**.



Tip: To listen to music using a wireless headset pair your phone with a compatible Bluetooth headset (sold separately). To switch Bluetooth on, select **Menu** >  > **Bluetooth**, and switch **Bluetooth** on.

VOICE RECORDER

Record a sound clip

1. Select **Menu** >  > **Sound Recorder**.
2. To record, select .
3. To stop recording, select .

VIDEO PLAYER

Watch your favorite videos wherever you are.

Play a video

1. Select **Menu** >  > **Video Player**.
2. Select the video, and press the scroll key to play it.
3. Press the scroll key to pause and resume playback while watching the video.



Tip: Not all video formats are supported.

9 Radio

FIND AND SAVE RADIO STATIONS

You need to connect a compatible headset to listen to the radio. The headset acts as an antenna. Troubleshooting tip: if the radio does not work, make sure that the headset is properly connected.

Search for radio stations

Select **Menu** > . If you open the radio for the first time, it will automatically search for the available stations and start playing. To switch to another found station, scroll left or right.

To search for all available stations later, select  > **Auto Search**.

LISTEN TO RADIO

Did you find a good radio station? Next, start listening to it!

Listen to your favorite radio stations on your phone

Select **Menu** > . The radio starts playing the last station you have listened.

To change the station, scroll left or right.

To change the volume, scroll up or down.

To close the radio, press the scroll key.

10 Clock, calendar, and calculator

SET THE TIME AND DATE MANUALLY

You can set your phone clock manually.

Change the time and date



1. Select **Menu** >  > **Date & time**.
2. Switch **Auto update** off.
3. Select **Set date** to change the date or **Set time** to change the time.

CLOCK

Learn how to use the clock and timers to be on time.



Set an alarm

No clock around? Use your phone as an alarm clock.



1. Select **Menu** > .
2. Select  > **Add alarm** to add an alarm.
3. Scroll up or down until the correct hour is highlighted, and then scroll right to set the minutes in a similar manner. Scroll right to select AM or PM.
4. Select **Done**. To set the alarm sound, select the alarm and then select  > **Edit**. You can also give the alarm a name and set it to repeat on certain days. To turn off an alarm, select the alarm.

Countdown timer

If you need an alarm but don't want to create one in the alarm clock, use the countdown timer. You can, for example, time something that's cooking in the kitchen.

1. Select **Menu** > , and scroll right to .
2. Use the number keys to set the time.
3. Select **Start**.



Stopwatch

1. Select **Menu** >  and scroll right to .
2. Select **Start**.
3. Press the scroll key to stop the watch. If you want the time to continue, select **Recover**.

CALENDAR

Need to remember an event? Add it to your calendar.

Add a calendar reminder

1. Select **Menu** > .
2. Select a date and  > **Create**.
3. Type in a name for the event.
4. On the **Start Date** field, select the date.
5. On the **Start Time** field, select the time.
6. Select whether to add an alert to the event.

CALCULATOR

Learn how to add, subtract, multiply and divide with your phone calculator.

How to calculate

1. Select **Menu** >  > **Calculator**.
2. Enter the first factor of your calculation, use the scroll key to select the operation, and enter the second factor.
3. Press the scroll key to get the result of the calculation.

11 Update the phone software

SOFTWARE UPDATES

Keep your phone up to date to get new and enhanced features for your phone. Updating the software may also improve your phone's performance.

Keep your phone up to date

Select **Menu** >  > **System update**. Your phone starts looking for available updates. To start an update, select the found new software update.

12 Copy content and check the memory

COPY CONTENT

Copy content created by you between your phone and computer.

Copy content between your phone and computer



To copy content from the phone memory, you need to have a memory card inserted in your phone.

1. Connect your phone to a compatible computer with a compatible USB cable.
2. Select **USB storage**.
3. On your computer, open a file manager, such as Windows Explorer, and browse to your phone. You can see the content stored on your phone and on the memory card, if inserted.
4. Drag and drop items between your phone and computer.

UNINSTALL APPS

You can uninstall apps pre-installed on your phone.

Uninstall apps

1. Select **Menu** >  > **Apps** > **Downloaded**.
2. Select the app you want to uninstall, and select  > **Uninstall**.

MEMORY

When needed, you can check how much used and how much free memory you have on your phone.

Check the amount of used and free memory

Select **Menu** >  > **Storage** > **Internal storage** or **SD card**. The phone shows the amount of available memory, the amount of used memory, and the amount of free memory.

13 Tools

NOTIFICATION CENTER

To quickly check your missed calls and received messages, open the notification center.

Check your calls and messages

To open the notification center, go to the home screen and press and hold #. On the **NOTIFY** tab, you can see your missed calls and received messages. On the **SWITCH** tab you can, for example, mute or unmute your phone, switch Bluetooth on quickly, and adjust the display brightness.

FILE EXPLORER

Need to find those important files quickly? Open the File Explorer.

Find your files

To find your files quickly, select **Menu** >  and the file type folder, such as **Video**. To find items on your memory card, select **External Storage**.

TORCH



Use the flashlight

Select **Menu** >  > **Torch**. To switch the flashlight off, press the scroll key.

Do not shine the light in anyone's eyes.

NOTES

Write a note

1. Select **Menu** >  > **Note** >  > **New Note**.
2. Write the note and select  > **Save**.

To share the note, open the note, select  > **Share**, and select to share the note using Bluetooth or Messaging.

14 Settings

CHANGE THE SETTINGS

Reset your phone

Accidents may happen and your phone may stop responding. You can restore the original factory settings, but be careful, since this reset removes all data you have saved in the phone memory and all your personalization.

If you are disposing your phone, note that you are responsible of removing all private content.

1. Select **Menu** >  > **Reset** > **Factory data reset**.
2. Select **Reset phone**. The phone is reset and all data is removed.
3. The phone reboots.

Airplane mode

When you are flying or in other locations where phone use is restricted, use the airplane mode.

To activate the airplane mode, select **Menu** >  > **More**, and switch **Airplane mode** on.

The airplane mode closes connections to the cellular network and switches your device's wireless features off. Comply with the instructions and safety requirements given by, for example, an airline, and any applicable laws and regulations.

Restrict mobile data usage with data roaming



If you want to avoid extra costs, you can change the data roaming settings.

Select **Menu** >  > **More** > **Mobile networks**, and switch **Data roaming** off.

Change the time and date



1. Select **Menu** >  > **Date & time**.
2. Switch **Auto update** off.
3. Select **Set date** to change the date or **Set time** to change the time.

Choose a new wallpaper

1. Select **Menu** >  > **Display** > **Wallpaper**, and select **Gallery** to choose a wallpaper from the photos on your phone or **Wallpapers** to choose a wallpaper from the collection.
2. Scroll to a wallpaper and select it to see how it looks on the screen.
3. Select .

Change your ring and notification tone

Select **Menu** >  > **Audio profiles**. You can select a pre-defined audio profile, or create your own.

1. To create your own, select  > **Add**. select the ring tone and notification tones.
2. Write a name for the profile and select **OK**.
3. Select the profile and **Edit**. You can now
4. To save the profile, select .
5. To switch on the profile, select the profile and **Use**.

15 Product and safety information

FOR YOUR SAFETY

Read these simple guidelines. Not following them may be dangerous or against local laws and regulations. For further info, read the complete user guide.

SWITCH OFF IN RESTRICTED AREAS



Switch the device off when mobile device use is not allowed or when it may cause interference or danger, for example, in aircraft, in hospitals or near medical equipment, fuel, chemicals, or blasting areas. Obey all instructions in restricted areas.

ROAD SAFETY COMES FIRST



Obey all local laws. Always keep your hands free to operate the vehicle while driving. Your first consideration while driving should be road safety.

INTERFERENCE



All wireless devices may be susceptible to interference, which could affect performance.

AUTHORIZED SERVICE



Only authorized personnel may install or repair this product.

BATTERIES, CHARGERS, AND OTHER ACCESSORIES



Use only batteries, chargers, and other accessories approved by HMD Global Oy for use with this device. Do not connect incompatible products.

KEEP YOUR DEVICE DRY



If your device is water-resistant, see its IP rating in the device's technical specifications for more detailed guidance.

PROTECT YOUR HEARING



To prevent possible hearing damage, do not listen at high volume levels for long periods. Exercise caution when holding your device near your ear while the loudspeaker is in use.

SAR



This device meets RF exposure guidelines when used either in the normal use position against the ear or when positioned at least 1.5 centimetres (5/8 inch) away from the body. The specific maximum SAR values can be found in the Certification Information (SAR) section of this user guide. For more information, see the Certification Information (SAR) section of this user guide or go to www.sar-tick.com.

NETWORK SERVICES AND COSTS

Using some features and services, or downloading content, including free items, require a network connection. This may cause the transfer of large amounts of data, which may result in data costs. You may also need to subscribe to some features.

You can only use your device on the GSM 900/1800MHz, TDSCDMA B34 and B39, and TDD LTE B39, B40, B41/38 networks. You need a subscription with a service provider.

EMERGENCY CALLS

 **Important:** Connections in all conditions cannot be guaranteed. Never rely solely on any wireless phone for essential communications like medical emergencies.

Before making the call:

- Switch the phone on.
 - If the phone screen and keys are locked, unlock them.
 - Move to a place with adequate signal strength.
1. Press the right function key repeatedly, until the home screen is shown.
 2. Type in the official emergency number for your present location. Emergency call numbers vary by location.
 3. Press the call key.
 4. Give the necessary info as accurately as possible. Do not end the call until given permission to do so.

You may also need to do the following:

- Put a SIM card in the phone.
- If your phone asks for a PIN code, type in the official emergency number for your present location, and press the call key.
- Switch the call restrictions off in your phone, such as call barring, fixed dialling, or closed user group.

TAKE CARE OF YOUR DEVICE

Handle your device, battery, charger and accessories with care. The following suggestions help you keep your device operational.

- Keep the device dry. Precipitation, humidity, and all types of liquids or moisture can contain minerals that corrode electronic circuits.
- Do not use or store the device in dusty or dirty areas.
- Do not store the device in high temperatures. High temperatures may damage the device or battery.
- Do not store the device in cold temperatures. When the device warms to its normal temperature, moisture can form inside the device and damage it.
- Do not open the device other than as instructed in the user guide.
- Unauthorized modifications may damage the device and violate regulations governing radio devices.
- Do not drop, knock, or shake the device or the battery. Rough handling can break it.
- Only use a soft, clean, dry cloth to clean the surface of the device.
- Do not paint the device. Paint can prevent proper operation.
- Keep the device away from magnets or magnetic fields.
- To keep your important data safe, store it in at least two separate places, such as your device, memory card, or computer, or write down important info.

During extended operation, the device may feel warm. In most cases, this is normal. To avoid getting too warm, the device may automatically slow down, close apps, switch off charging, and if necessary, switch itself off. If the device is not working properly, take it to the nearest authorized service facility.

RECYCLE



Always return your used electronic products, batteries, and packaging materials to dedicated collection points. This way you help prevent uncontrolled waste disposal and promote the recycling of materials. Electrical and electronic products contain a lot of valuable materials, including metals (such as copper, aluminum, steel, and magnesium) and precious metals (such as gold, silver, and palladium). All materials of the device can be recovered as materials and energy.

CROSSED-OUT WHEELIE BIN SYMBOL

Crossed-out wheelie bin symbol



The crossed-out wheelie-bin symbol on your product, battery, literature, or packaging reminds you that all electrical and electronic products and batteries must be taken to separate collection at the end of their working life. Remember to remove personal data from the device first. Do not dispose of these products as unsorted municipal waste: take them for recycling. For info on your nearest recycling point, check with your local waste authority, or read about HMD's take-back program and its availability in your country at www.hmd.com/phones/support/topics/recycle.

BATTERY AND CHARGER INFORMATION

Battery and charger

Use your device only with an original BL-4UL rechargeable battery.

Charge your device with AC-19C charger. Charger plug type may vary.

HMD Global may make additional battery or charger models available for this device.

Battery type: BL-4UL

Battery and charger safety info

To unplug a charger or an accessory, hold and pull the plug, not the cord.

When your charger is not in use, unplug it. If left unused, a fully charged battery will lose its charge over time.

Always keep the battery between 59°F and 77°F (15°C and 25°C) for optimal performance. Extreme temperatures reduce the capacity and lifetime of the battery. A device with a hot or cold battery may not work temporarily. Accidental short-circuiting can happen when a metallic object touches the metal strips on the battery. This may damage the battery or the other object.

Do not dispose of batteries in a fire as they may explode. Obey local regulations. Recycle when possible. Do not dispose as household waste.

Do not dismantle, cut, crush, bend, puncture, or otherwise damage the battery in any way. If a battery leaks, do not let liquid touch skin or eyes. If this happens, immediately flush the affected areas with water, or seek medical help. Do not modify, attempt to insert foreign objects into the battery, or immerse or expose it to water or other liquids. Batteries may explode if damaged.

Use the battery and charger for their intended purposes only. Improper use, or use of unapproved or incompatible batteries or chargers may present a risk of fire, explosion, or other hazard, and may invalidate any approval or warranty. If you believe the battery or charger is damaged, take it to a service centre or your phone dealer before continuing to use it. Never use a damaged battery or charger. Only use the charger indoors. Do not charge your device during a lightning storm.

SMALL CHILDREN

Your device and its accessories are not toys. They may contain small parts. Keep them out of the reach of small children.

MEDICAL DEVICES

Operation of radio transmitting equipment, including wireless phones, may interfere with inadequately shielded medical devices' function. Consult a physician or the medical device's manufacturer to determine if it is adequately shielded from external radio energy.

IMPLANTED MEDICAL DEVICES

To avoid potential interference, manufacturers of implanted medical devices, such as a (cardiac) pacemaker, implanted cardioverter defibrillator, implanted cochlea (bionic ear), etc., recommend a minimum separation of 6 inches (15.3 centimetres) between a wireless device and the medical device. Persons who have such devices should:

- Always keep the wireless device more than 6 inches (15.3 centimetres) from the medical device.
- Not carry the wireless device in a breast pocket.
- Hold the wireless device to the ear opposite the medical device.
- Switch the wireless device off if there is any reason to suspect that interference is taking place.
- Follow the manufacturer directions for the implanted medical device.

If you have any questions about using your wireless device with an implanted medical device, consult your health care provider.

HEARING



Warning: When you use the headset, your ability to hear outside sounds may be affected. Do not use the headset where it can endanger your safety.

Some wireless devices may interfere with some hearing aids.

PROTECT YOUR DEVICE FROM HARMFUL CONTENT

Your device may be exposed to viruses and other harmful content. Take the following precautions:

- Be cautious when opening messages. They may contain malicious software or otherwise be harmful to your device or computer.
- Be cautious when accepting connectivity requests, browsing the internet, or downloading content. Do not accept Bluetooth connections from sources you do not trust.
- Only install and use services and software from sources that you trust and that offer adequate security and protection.
- Install antivirus and other security

software on your device and any connected computer. Only use one antivirus app at a time. Using more may affect performance and operation of the device and/or computer.

- If you access preinstalled bookmarks and links to third party internet sites, take the appropriate precautions. HMD Global does not endorse or assume liability for such sites.

VEHICLES

Radio signals may affect improperly installed or inadequately shielded electronic systems in vehicles. For more info, check with the manufacturer of your vehicle or its equipment. Only authorized personnel should install the device in a vehicle. Faulty installation may be dangerous and invalidate your warranty. Check regularly that all wireless device equipment in your vehicle is mounted and operating properly. Do not store or carry flammable or explosive materials in the same compartment as the device, its parts, or accessories. Do not place your device or accessories in the air bag deployment area.

POTENTIALLY EXPLOSIVE ENVIRONMENTS

Switch your device off in potentially explosive environments, such as near gasoline pumps. Sparks may cause an explosion or fire resulting in injury or death. Note restrictions in areas with fuel; chemical plants; or where blasting operations are in progress. Areas with a potentially explosive environment may not be clearly marked. These usually are areas where you are advised to switch your engine off, below deck on boats, chemical transfer or storage facilities, and where the air contains chemicals or particles. Check with the manufacturers of vehicles using liquefied petroleum gas (such as propane or butane) if this device can be safely used in their vicinity.

ABOUT DIGITAL RIGHTS MANAGEMENT

When using this device, obey all laws and respect local customs, privacy and legitimate rights of others, including copyrights. Copyright protection may prevent you from copying, modifying, or transferring photos, music, and other content.

COPYRIGHTS AND OTHER NOTICES



Disclaimer: The operation system of the product might be upgraded. If the ROM and system file was cracked or changed illegally, the device will be unstable and exposed to security risk and attack. Under no circumstances shall the manufacturer provide support or be responsible for any loss, consequential or indirect damages howsoever caused.

Copyrights and other notices

The availability of products, features, apps and services may vary by region. For more info, contact your dealer or your service provider. This device may contain commodities, technology or software subject to export laws and regulations from the US and other countries. Diversion contrary to law is prohibited.

The contents of this document are provided "as is". Except as required by applicable law, no warranties of any kind, either express or implied, including, but not limited to, the implied warranties of merchantability and fitness for a particular purpose, are made in relation to the accuracy, reliability or contents of this document. HMD Global reserves the right to revise this document or withdraw it at any time without prior notice.

To the maximum extent permitted by applicable law, under no circumstances shall HMD Global or any of its licensors be responsible for any loss of data or income or any special, incidental, consequential or indirect damages howsoever caused.

Reproduction, transfer or distribution of part or all of the contents in this document in any form without the prior written permission of HMD Global is prohibited. HMD Global operates a policy of continuous development. HMD Global reserves the right to make changes and improvements to any of the products described in this document without prior notice.

HMD Global does not make any representations, provide a warranty, or take any responsibility for the functionality, content, or end-user support of third-party apps provided with your device. By using an app, you acknowledge that the app is provided as is.

Downloading of maps, games, music and videos and uploading of images and videos may involve transferring large amounts of data. Your service provider may charge for the data transmission. The availability of particular products, services and features may vary by region. Please check with your local dealer for further details and availability of language options.

Certain features, functionality and product specifications may be network dependent and subject to additional terms, conditions, and charges.

All are subject to change without notice.

HMD Global Privacy Policy, available at <http://www.hmd.com/privacy>, applies to your use of the device.

HMD Global Oy is the exclusive licensee of the Nokia brand for phones & tablets. Nokia is a registered trademark of Nokia Corporation.

The Bluetooth word mark and logos are owned by the Bluetooth SIG, Inc. and any use of such marks by HMD Global is under license.

All other trademarks are the property of their respective owners.

Names and amounts of hazardous substances in the product

产品中有害物质的名称和含量						
部件名称 (Parts)	有害物质 (Hazardous Substances)					
	铅 (Pb)	汞 (Hg)	镉 (Cd)	六价铬 (Cr ⁶⁺)	多溴联苯 (PBBs)	多溴二苯醚 (PBDEs)
主机 (Phone)	×	○	○	○	○	○
电池 (Battery)	×	○	○	○	○	○
附件 (Accessories)	充电器 (Charger)	×	○	○	○	○
	其他附件 (Other Accessories)	×	○	○	○	○

本表格依据SJ/T 11364 的规定编制
 ○：表示有害物质在该部件所有均质材料中的含量均在GB/T26572 标准规定的限量要求以下。
 ×：表示该有害物质至少在该部件的某一均质材料中的含量超出 GB/T 26572 标准规定的限量要求。

注：本产品标有“×”的原因是：现阶段没有可供选择的替代技术或部件。

10 主机，充电器及其它附件

5 电池

上述电子电气产品的「环保使用期限」，意指产品在正常使用条件下，产品中的有害物质自产品生产日期算起在上述标示期限内不会发生泄露或突变。在此期间，使用本产品不会对环境造成污染或对人身产生身体伤害。

RoHS table